

# CONTROL of Access Driveways

NEW JERSEY  
DEPARTMENT OF TRANSPORTATION

**REGULATIONS**

**CONTROL OF ACCESS DRIVEWAYS**

**July, 1977**

**NEW JERSEY DEPARTMENT OF TRANSPORTATION**

**BUREAU OF MAINTENANCE**

**1035 Parkway Avenue**

**Trenton, New Jersey**

## **FOREWORD**

This publication has been prepared to assist those concerned with access driveways along state highways.

It sets forth regulations for the control of access driveways within the New Jersey State Highway System.

Section III, page 2, describes procedures for permit applications but does not contain such applications. Required applications may be obtained from the Bureau of Maintenance Permit Section and Regional Offices of the Construction and Maintenance Unit.

**TABLE OF CONTENTS**

<b>SECTION</b>	<b>PAGE</b>
I. Introduction .....	1
II. Authority .....	2
III. Permit Provisions .....	2-4
*Reg. D 3.1 Permit, when required .....	2
3.2 Types of Permits .....	3
3.3 Application for Access Driveway .....	3
3.4 Plans to support application .....	3
3.5 Fees .....	4
3.6 Refunds .....	4
3.7 Duration .....	4
3.8 Extension .....	4
3.9 Renewal .....	4
IV. Construction and Maintenance Unit Offices and Boundaries .....	5-6
V. Definitions .....	7-12
*Reg. D 5.1 Terms .....	7, 8, 12
5.2 Sketches Illustrating Definitions .....	9-11
(Figure 2, 3 & 4)	
VI. Curbing .....	12-13
*Reg. D 6.1 Requirements .....	12
6.2 Description .....	12
6.3 Specifications for Class "B" Concrete .....	12
6.4 9" x 20" White Concrete Vertical Curb .....	12
6.5 Alinement and Grade .....	12
6.6 Expansion Joints .....	12
6.7 Type of Finish .....	12
6.8 Curb Depressions .....	13
VII. Sidewalk Area .....	13-16
*Reg. D 7.1 Improved or Unimproved Areas .....	13
7.2 Requirements .....	13-16
7.3 Description .....	16
7.4 Concrete Sidewalk .....	16
VIII. Installation of Pipes .....	16-17
*Reg. D 8.1 Jurisdiction .....	16
8.2 Pipes Under Driveways .....	16
8.3 Piping Along Frontage .....	16, 17
8.4 Cost .....	17
IX. General Restrictions .....	17-18
*Reg. D 9.1 Right-of-Way Encroachment .....	17
9.2 Trees and Shrubbery .....	17

**TABLE OF CONTENTS – Continued**

<b>SECTION</b>	<b>PAGE</b>
9.3 Advertising Signs or Devices . . . . .	17
9.4 Protection of the Traveling Public . . . . .	17
9.5 Protection from suits . . . . .	18
9.6 Protection of Structures and Facilities . . . . .	18
9.7 Existing Catch Basins . . . . .	18
9.8 Drainage Rights . . . . .	18
9.9 Restriction of New Pavement . . . . .	18
9.10 Construction within Right-of-Way . . . . .	18
9.11 Lighting . . . . .	18
9.12 Alteration to Driveway . . . . .	18
X. Number and Arrangement of Driveways . . . . .	18-19
*Reg. D 10.1 Basic Principles . . . . .	18, 19
10.2 Frontages less than one hundred feet . . . . .	19
10.3 Frontages of one hundred feet or more . . . . .	19
10.4 Arrangement of two or more driveways . . . . .	19
10.5 Corner Property . . . . .	19
10.6 Joint Driveways . . . . .	19
XI. Driveway Surfacing . . . . .	19-20
*Reg. D 11.1 Driveway Surfacing . . . . .	19
11.2 Paving of Curblines . . . . .	19, 20
11.3 Concrete Pavement . . . . .	20
11.4 Bituminous Pavement . . . . .	20
XII. Control Dimensions . . . . .	20-21
*Reg. D 12.1 Edge Clearance . . . . .	20
12.2 Curblines . . . . .	20
12.3 Driveway Width . . . . .	20
12.4 Driveway Angle . . . . .	20
12.5 Radius of Curvature . . . . .	20
12.6 Distance Between Driveways . . . . .	21
12.7 Setback . . . . .	21
12.8 Corner Clearance . . . . .	21
12.9 Driveway Alignment and Profile . . . . .	21
XIII. Relocation or Removal of Structures within the Limits of Driveways . . . . .	21-23
*Reg. D 13.1 Jurisdiction of Structures . . . . .	21
13.2 Removal of Curb . . . . .	22
13.3 Relocation of Drainage Structures . . . . .	22
13.4 Removal of Guard Rail . . . . .	22
13.5 Relocation of Official Signs . . . . .	22
13.6 Relocation of Departmental Electrical Facilities . . . . .	22
13.7 Relocation of Utility Poles . . . . .	22
13.8 Relocation of Highway Lighting Poles . . . . .	22

**TABLE OF CONTENTS — Continued**

<b>SECTION</b>	<b>PAGE</b>	
13.9	Departmental Electrical Cables and Conduit Under Drives . . . . .	22, 23
13.10	Relocation of a Fire Hydrant . . . . .	23
XIV.	Materials and Workmanship . . . . .	23
*Reg. D	14.1 Approval . . . . .	23
	14.2 Cost . . . . .	23
XV.	General Information . . . . .	23-26
*Reg. D	15.1 Freeways, Parkways, and Interstate Routes . . . . .	23
	15.2 Expenditures . . . . .	23, 25
	15.3 Landscaping . . . . .	25
	15.4 Policy Governing the Construction of Driveways . . . . .	25
	15.5 Common Drives . . . . .	25
	15.6 Drive-in Theater Entrances . . . . .	25
	15.7 Surplus Right-of-Way . . . . .	25
	15.8 Acceleration and Deceleration Lanes . . . . .	25, 26
	15.9 Internal Parking . . . . .	26
XVI.	Local Ordinances and Regulations . . . . .	26
*Reg. D	16.1 Setback and Driveway Width . . . . .	26
XVII.	Special Conditions . . . . .	26-27
*Reg. D	17.1 Conditions . . . . .	26
	17.2 Guarantee . . . . .	26
	17.3 Signalized Intersection . . . . .	26, 27
XVIII.	Illustrations of Standard Driveways . . . . .	27-43
*Reg. D	18.1 Terms . . . . .	27
	18.2 Sketches and Layouts . . . . .	27-43
XIX.	Conditions For High Traffic Volume Generators . . . . .	44
*Reg. D	19.1 Statement of Accompany Application . . . . .	44
	19.2 Plans . . . . .	44
	19.3 Specifications . . . . .	44
XX.	Complex Driveway Designs . . . . .	45-51
XXI.	Violations . . . . .	52
*Reg. D	21.1 Violation . . . . .	52
	21.2 Penalty . . . . .	52
XXII.	Conclusion . . . . .	52
	Index . . . . .	53-56

\* Regulation Driveways

You're viewing an archived copy from the New Jersey State Library.

## SECTION I

### INTRODUCTION

By virtue of the powers and duties set forth in Title 27 of the Revised Statutes, and in the interests of highway safety, on March 17, 1933, the New Jersey State Highway Commission adopted certain regulations outlining the procedure, limitations and methods of construction under which abutting owners may be permitted to construct vehicular access to State Highways. The State Highway Commissioner, under date of February 6, 1948, approved a revision of these Rules and Regulations.

The efficiency and safety of a highway depends to a large extent upon the amount and character of roadside interference with the movement of traffic. Most of the interference originates in vehicular movements to and from businesses, residences, or other developments along the highways. Accordingly, regulation and overall control of driveway connections are necessary to provide efficient and safe operation, and to utilize the full potential of the highway investment. Abutting landowners have certain rights of access consistent with their needs. Road users have certain rights to freedom of movement, safety and efficient expenditures of their highway funds.

To give a more modern outlook, the Division of Maintenance and Equipment, of the New Jersey Department of Transportation, has compiled this manual as a revision of its Rules and Regulations **to regulate and control the location, design, and operation of access driveways.**

**In planning roadside enterprises, the appearance and safety of the roadside could be greatly enhanced if the developer would consult with the District Superintendent, Construction and Maintenance Unit while the enterprise is in the planning stage.**

The developer should give consideration to the following:

1. Proper design of entrances and exits.
2. Adequate setback of buildings and other structures.
3. Ample parking on premises.
4. Display of advertising.
5. In situations where large traffic generators, such as a shopping center complex is proposed, preliminary discussions should be held with the District Superintendent, Construction and Maintenance Unit prior to determining location of structures, parking facilities, and access roadways.

## SECTION II AUTHORITY

New Jersey Statutes Annotated, "Title 27 Highways," prescribes certain powers and duties of the Commissioner of Transportation. Among these duties he is authorized to determine and adopt rules, regulations and specifications and enter into contracts covering all matters and things incidental to the acquisition, improvement, betterment, construction, maintenance and repair of State Highways.

In this connection, attention is directed to Section 27:7-44.1 of "Title 27 Highways," which provides as follows:

"Nor shall any person enter upon or construct any works in or upon any State Highway except under such conditions and regulations as the Commissioner may prescribe. Whenever any encroachment may exist without warrant of law in any road when taken over as a State Highway, the Commissioner shall notify the Attorney General, who shall proceed to cause the same to be removed as by law provided.

Any person guilty of any violation of this Section shall be liable to a fine not exceeding one hundred dollars (\$100) for each such days violation, and the costs of prosecution, to be recovered by a civil action in the name of the State before any court of competent jurisdiction, by the Commissioner. Said fines shall be paid into the State Treasury to the credit of the funds available for construction, maintenance and repair of roads.

Any such violation may be removed from any State Highway as a trespass by a civil action brought by the Commissioner in the Superior Court. The court may proceed in the action in a summary manner or otherwise."

This section forbids any person from constructing any work within the State Highway System except under the conditions and regulations prescribed by the Commissioner of Transportation.

## SECTION III PERMIT PROVISIONS

### Regulation Driveways

- 3.1 **PERMIT: WHEN REQUIRED:** Any person, before constructing one or more driveways entering on any State Highway in New Jersey or intending to reconstruct, change or modify any existing driveway; or proposing to construct sidewalk curbing or any other related work

within the limits of highway Right of Way must apply to and obtain a permit from the New Jersey Department of Transportation.

**3.2 TYPES OF PERMITS:**

- (a) Private Driveway
- (b) Combined Residence and Business
- (c) Automobile Service Station
- (d) Commercial Minor
- (e) Commercial Major

**3.3 APPLICATION FOR ACCESS DRIVEWAY:** Applications for driveways may be obtained from the Construction & Maintenance Unit Regional Offices or from the Department's Central Permits Office. (See Section IV, Page 5). Completed application with the required fee is to be forwarded to the Regional Office having jurisdiction over the area in which the driveway is to be constructed. (See Figure 1, Page 6). The application can only be signed by the property owner or designated Power of Attorney. Application fees must be in the form of a check or money order made payable to the New Jersey Department of Transportation: CASH WILL NOT BE ACCEPTED.

**3.4 PLANS TO SUPPORT APPLICATION:**

- (a) Application for private access driveway must be supported by six (6) copies of a detailed sketch or plan showing location and type of proposed drives in relation to the gutter and/or curb-line.
- (b) Application for access driveway involving automobile service stations or commercial establishments must be supported by six (6) copies of a detailed plan to a scale no greater than 50' to 1", preferably 30' to 1" using an engineer's scale. The following information must be supplied:

- Site Location
- Property Lines
- Setback and location of structure
- Curb
- Sidewalk
- Drainage
- Existing and proposed contours
- Highway Electrical Installations
- Trees within Right of Way
- Advisory, Directional and Regulatory Signs
- Signs
- Poles
- Location of Driveways
- Driveway Width
- Driveway Alignment
- Curbline Opening
- Edge Clearance
- Type of Construction

Where Applicable:

- Driveway Contour
- Corner Clearance
- Radius of Curvature
- Parking Facilities
- Estimated Traffic Count for Access
- Speed-Change Lanes (Acceleration, deceleration, or left turn slots)

3.5 **FEES:**

(a) APPLICATION FEES	
Private Driveways	\$ 6.00
Combined Residence and Business	12.00
Automobile Service Station	25.00
Commercial Minor	25.00
Commercial Major	60.00
(b) PERMIT FEES	
Private Driveways: Each Curbline Opening	12.00
Combined Residence and Business	25.00
Each Curbline Opening:	
Automobile Service Station	50.00
Commercial Minor	50.00
Commercial Major: Without auxiliary lanes, acceleration, deceleration lanes, etc.	125.00
Commercial Major: With auxiliary lanes, acceleration, deceleration lanes, etc.	250.00
(c) Extension Fee — Private Driveways	10.00
All Others	20.00

3.6 **REFUNDS:** No refund will be made after an application has been filed.

3.7 **DURATION:** All construction work under the terms of the permit must be completed within one (1) year from date permit was issued, unless otherwise stated, or the permit is automatically lapsed.

3.8 **EXTENSION:** When the work under the terms of the permit is started within one (1) year from the date of issuance and cannot be completed in the indicated time limit unless otherwise stated, the permittee must request an extension of time under the same terms and conditions. A request by letter must be submitted to the appropriate Regional office for an extension of time with the required fee in the form of a check or money order. **CASH WILL NOT BE ACCEPTED.**

3.9 **RENEWAL:** When the work under the terms of the permit does not get started within one (1) year from the date permit was issued, the permittee may reapply by application under the same terms and conditions of the original permit. The new application and plans must reflect any developments which would necessitate a change in the installation.

**SECTION IV**  
**CONSTRUCTION AND MAINTENANCE UNIT**  
**OFFICES AND BOUNDARIES**

**CENTRAL OFFICE:**

New Jersey Department of Transportation  
Bureau of Maintenance, Construction & Maintenance Unit  
1035 Parkway Avenue  
Trenton, New Jersey 08625  
Telephone: (609) 292-3446

**REGIONAL OFFICES:**

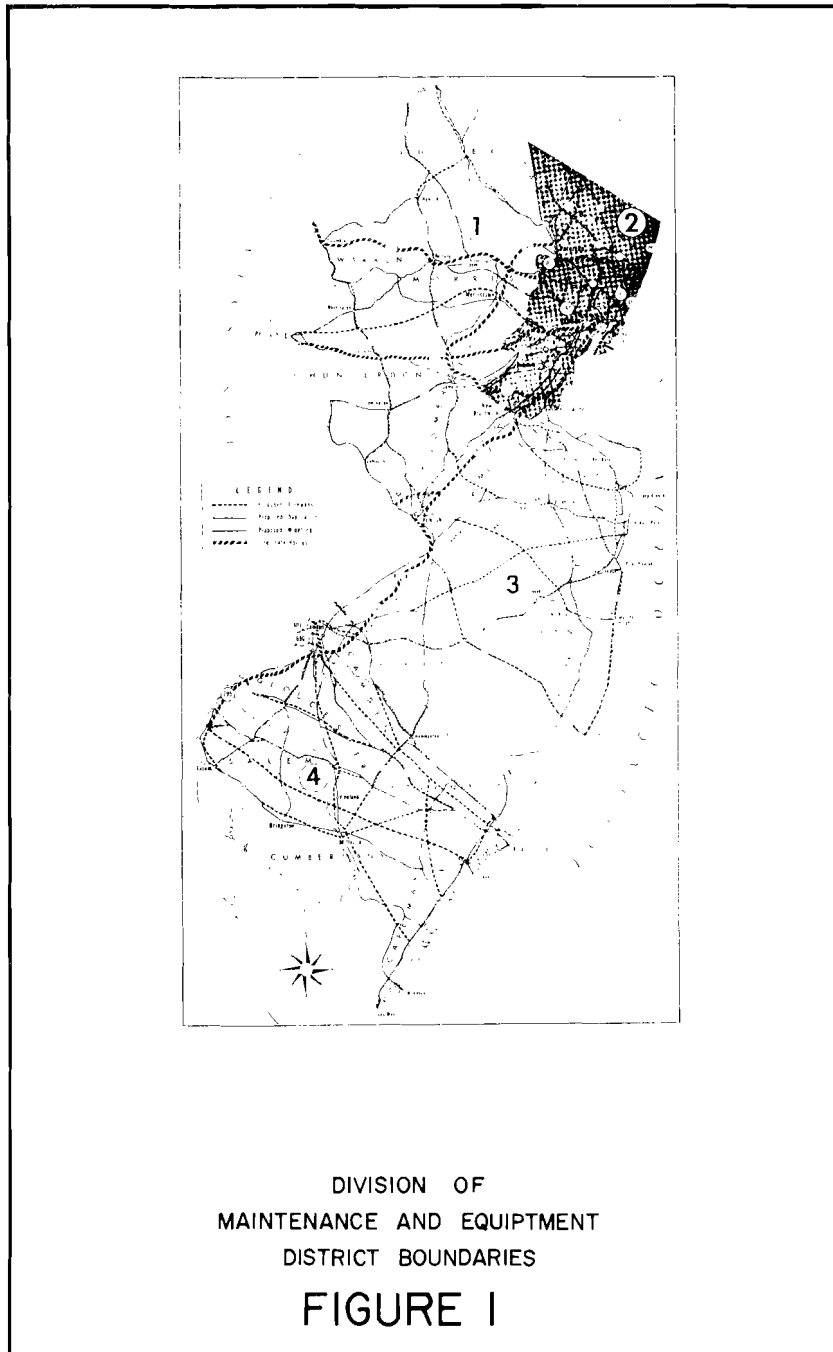
District #1 — Netcong  
New Jersey Department of Transportation  
P. O. Box # 55  
Netcong, New Jersey 07857  
Telephone: (201) 347-4415

District #2 — Newark  
New Jersey Department of Transportation  
Routes 1, 21 & 22  
Newark Junction  
Newark, New Jersey 07114  
Telephone: (201) 648-2814

District #3 — Freehold  
New Jersey Department of Transportation  
Route 9  
Box 272 B RD #4  
Howell, New Jersey 07731  
Telephone: (201) 431-4500

District #4 — Cherry Hill  
New Jersey Department of Transportation  
Route 70 at New Jersey Turnpike  
Cherry Hill, New Jersey 08034  
Telephone: (609) 428-6550

**REGIONAL BOUNDARIES:** Boundaries of each district are shown on map — Page 6.



## SECTION V DEFINITIONS

### Regulation Driveways

- 5.1 Whenever the following terms and abbreviations are used, their intent and meaning shall be interpreted as follows:

**BERM:** When the area from the curbline to right-of-way line is raised, normally eight (8) inches in height, it is defined as the berm. This is also sidewalk area.

**COMMERCIAL MAJOR:** Commercial entrances major are driveways serving shopping centers, business establishments, manufacturing plants, parking and/or sales lots, truck terminals, churches, recreational areas, subdivisions, housing projects and similar establishments where the expected traffic volume is 500 cars per day or more with or without speed-change lanes involved as shown by the applicants analysis of anticipated activity.

**COMMERCIAL MINOR:** Commercial entrances minor are driveways serving shopping centers, business establishments, manufacturing plants, parking and/or sales lots, truck terminals, churches, recreational areas, subdivisions, housing projects and similar establishments where the expected traffic volume is 500 cars per day or less. as shown by the applicants analysis of the anticipated activity.

**COMMON DRIVE:** A driveway with portions constructed on two adjoining properties.

**CONTROL OF ACCESS:** The condition where the right of owners or occupants of abutting land or other persons to access, light, air, or view in connection with a State Highway is fully or partially controlled by the Department of Transportation.

**CORNER CLEARANCE (C):** This is the distance from a projection of right-of-way lines perpendicular or radial to the curbline, thence along the curbline to nearest edge of proposed curbline opening; see C in Figure 4.

**CURBLINE: (CURB):** Generally means a line (whether curbing exists or not) which is the outer edge of the shoulder. It is also the gutter line. See curbline in figure 2, 3, and 4.

**CURBLINE OPENING (C.O.):** The overall opening dimension at the curbline, whether curbing exists or not, measured from the extreme outer edges of the radii; C.O. in Figures 2, 3, and 4.

**DISTANCE BETWEEN DRIVEWAYS (D):** The distance measured along the curbline between the tangent projections of the inside edges of two adjacent driveways to the same frontage. See (D) in Figure 3.

**DRIVEWAY ANGLE (Y):** The angle of 90 degrees or less between the driveway centerline and curbline; Y in figures 2, 3, and 4.

**DRIVEWAY WIDTH (COMPLEX):** See Sections XIX and XX.

**DRIVEWAY WIDTH (STANDARD) (W):** Narrowest width of driveway, within the sidewalk area measured parallel with the curbline; W in Figure 2 and 3.

**EDGE CLEARANCE (E):** The distance measured along the curbline from the lateral property line extended to the beginning of driveway. See E in Figures 2, 3, and 4.

**EXTENDED PROPERTY LINE (E. P. L.):** A line, radial or perpendicular to the highway curbline, at each end of the frontage, extending from the right-of-way line to the curbline; line (1) – (3) or (2) – (4) in Figure 2, 3, and 4.

**FRONTAGE:** The length along the highway right-of-way line of a single property tract between the lateral property lines; distance between (1) and (2) in Figures 2, 3, and 4.

**INSIDE RADIUS (U):** The inside or smaller curve radius on edge of driveway; U in Figure 3.

**MEDIAN:** That portion of a divided highway separating the traveled ways of traffic proceeding in opposite directions. See Figure 2.

**MONOLITHIC CURB:** When curb and gutter are constructed as one unit.

**OUTSIDE RADIUS (R):** The outside or larger curve radius on edge of driveway; R in Figures 2, 3, and 4.

**PRIVATE DRIVEWAY:** The entrance to residence, field and woods, roads and similar noncommercial and lightly used driveways.

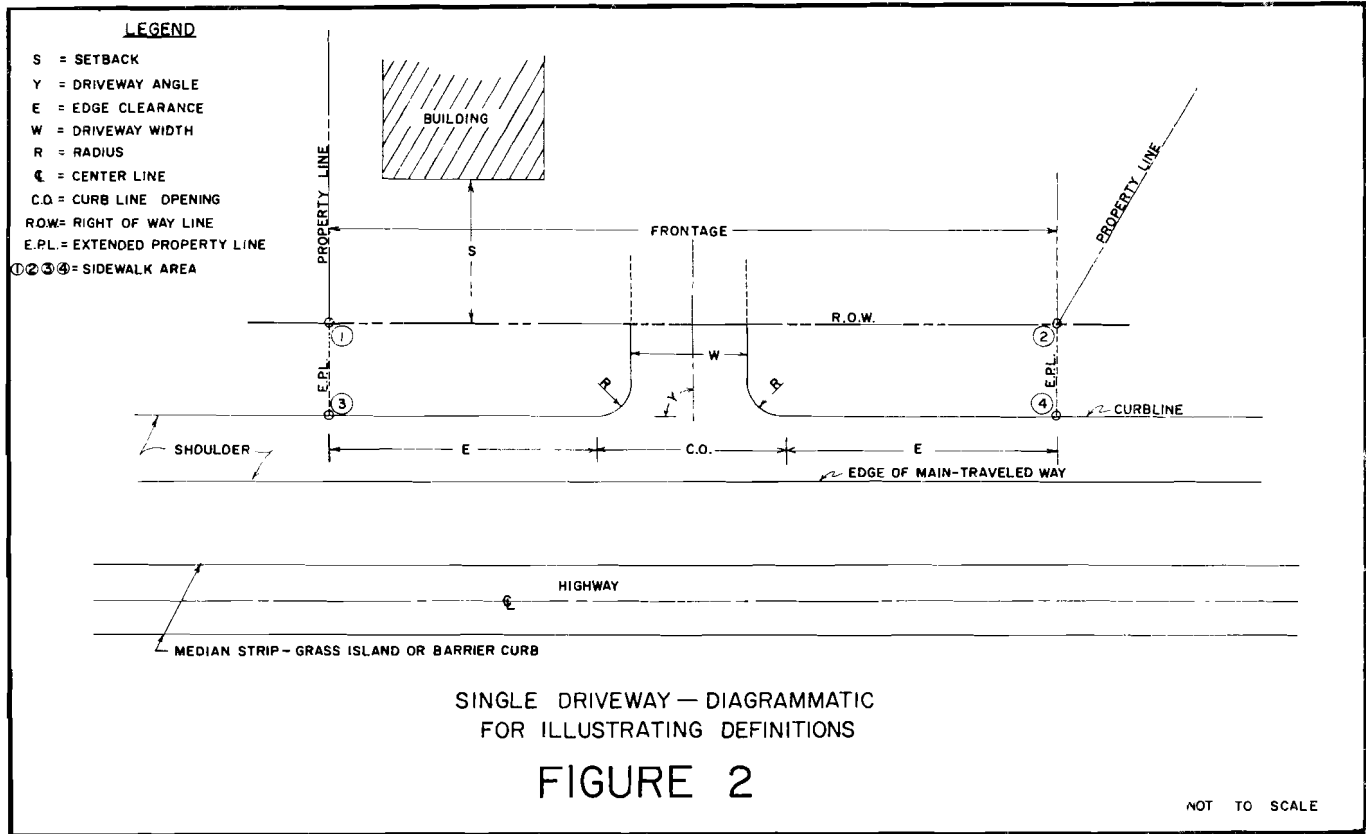
**RIGHT-OF-WAY:** Property acquired by the State Department of Transportation for highway purposes.

**RIGHT-OF-WAY LINE (R.O.W.):** The outer edge of State Highway property, separating highway property from abutting properties of others. See R.O.W. in Figure 2, 3, and 4.

**SETBACK (S):** The lateral distance between the right-of-way line and the roadside structure, such as a building, pump island, display stand or other object. See S in Figures 2, 3, and 4.

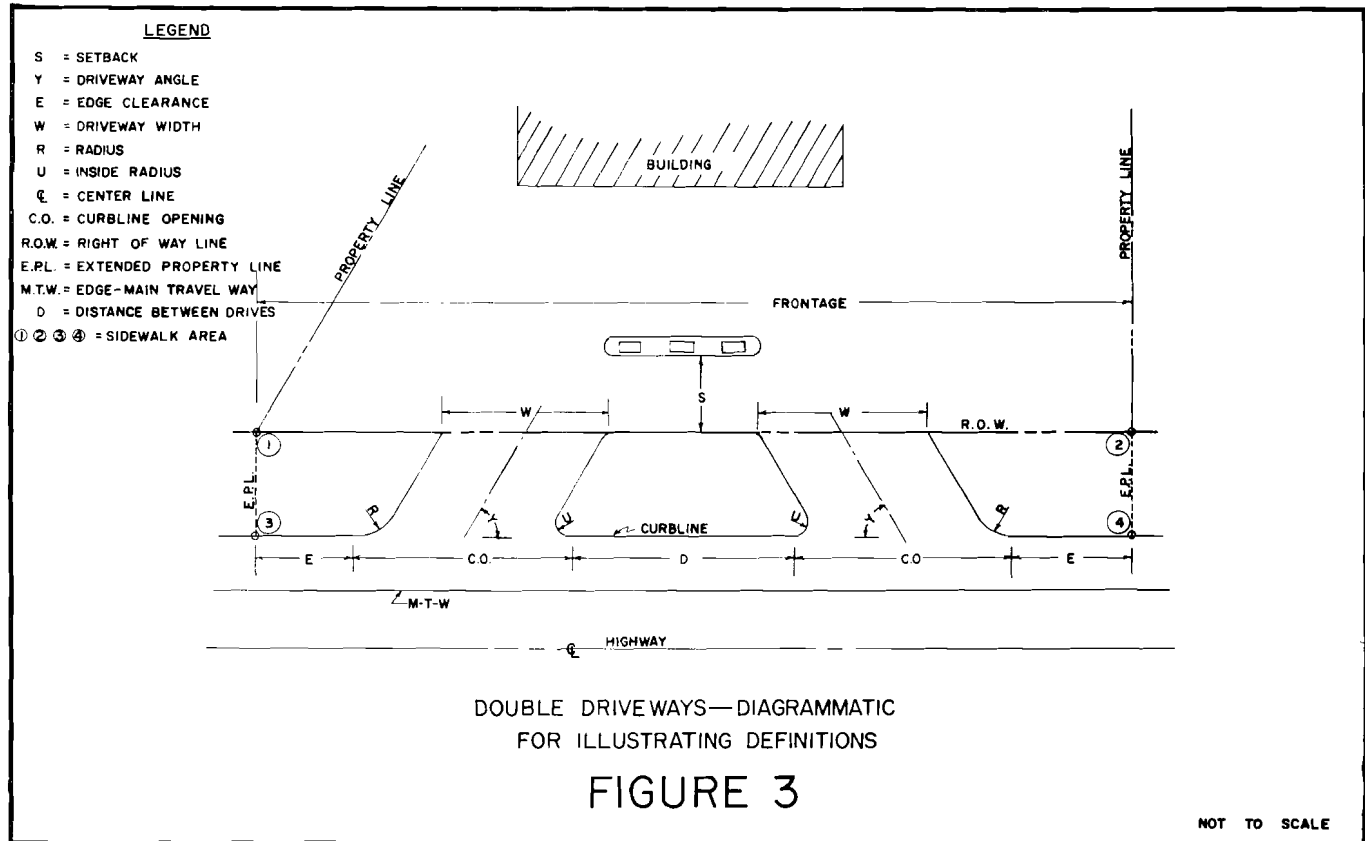
**SIDEWALK AREA:** That portion of the right-of-way that lies between the curbline and right-of-way line, and within the limits of the extended property lines. This area varies greatly in width. Whether improved or unimproved, it is considered and controlled as sidewalk area; Areas (1) – (2) – (3) – (4) in Figures 2, 3, and 4.

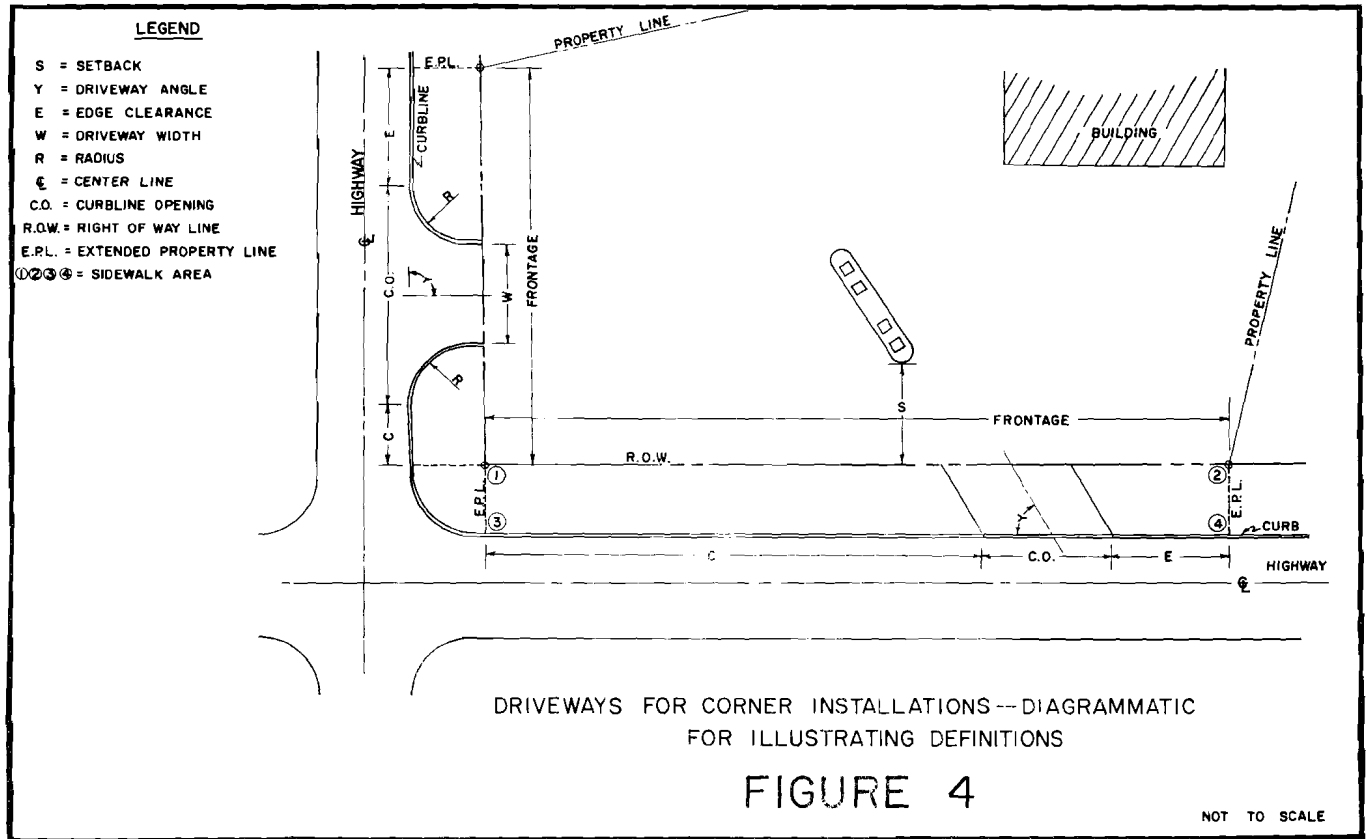
**SPEED-CHANGE LANE:** An auxiliary lane, deceleration lane, acceleration lane, including tapered areas, primarily for the acceleration or deceleration of vehicles entering or leaving the through traffic lanes. This lane should be of sufficient width and length of added pavement joining the traveled way to enable a driver to maneuver his vehicle onto it properly and once on it, to make the



6

10





11

necessary change between the speed of operation on the highway and the lower speed on the turning roadway. These lanes also function as storage lanes for turning traffic.

**TRAFFIC VOLUME COUNT:** An estimated count of the highest amount of traffic volume entering a property in a 24 hour period.

**SHOULDER:** The graded part of the right-of-way that lies between the edge of the main pavement (main-traveled way) and curblines. See Figure 2.

## SECTION VI

### CURBING

#### Regulation Driveways

- 6.1 **REQUIREMENTS:** At the discretion of the Department, curb construction shall be required on commercial and industrial frontage. The need for said construction shall be noted as a condition of the permit.
- 6.2 **DESCRIPTION:** All curbing to be constructed within Right-of-Way of any State Highway shall be white concrete, Class "B", air-entrained, and shall conform to New Jersey Department of Transportation Standard Specifications:
  - (a) **EXCEPTION TO RULE:** If curbing exists in an area where curbing is to be constructed, the curb should conform to color and dimension of that which exists.
- 6.3 **SPECIFICATIONS FOR CLASS "B" CONCRETE:** Concrete proportion shall consist of one part Portland Cement, one and three-quarter parts sand, and three and one-half parts crushed stone or washed gravel. This is called a 1:1 3/4:3 1/2 mix.
- 6.4 **9 " x 20 " WHITE CONCRETE VERTICAL CURB:** Curb shall be constructed of white concrete as shown on curb detail, Figure 5—Page 14. White concrete shall mean concrete composed of white cement, white sand and light-colored coarse aggregate.
- 6.5 **ALINEMENT AND GRADE:** The alinement and grade is to be determined by that established or existing in the area, and if need be, through the assistance of a qualified engineer.
- 6.6 **EXPANSION JOINTS:** Curb expansion joints shall be provided opposite joints in abutting concrete pavement and at approximately equal distances of not more than twenty (20) feet, except as otherwise specified as a condition of permit issued.
- 6.7 **TYPE OF FINISH:** The top shall be finished with a wood float to an even, smooth and dense surface and, as soon as the forms can be

removed, the face shall be similarly finished. The edges of curb shall be rounded to the required radius with suitable edging tools.

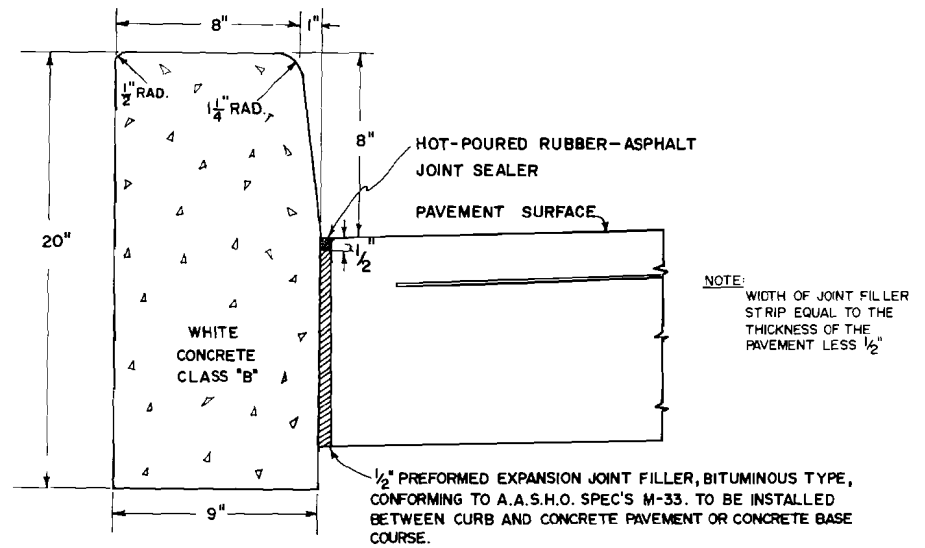
- 6.8 **CURB DEPRESSIONS:** Where curbing exists or is to be constructed, all driveways are to have depressed curbs, according to method shown on Figure 6 – Page 15. See Section XX for exception.
- (a) **EXISTING CURB:** To construct a depressed curb where curbing exists, the permittee will be required to entirely remove that section of existing curb and replace it with new curb.
  - (b) **NEW HIGHWAY CONSTRUCTION:** Curb reductions for driveways on new highway construction are not favored unless the improvement of the abutting parcel of land is in progress or is contemplated in the immediate future, in which case full and accurate plot plans should be furnished to the Department. See Reg. D3.4.
  - (c) **HEIGHT OF DEPRESSION:** The top of the depressed section of curb shall be 1½" higher than and parallel to the established gutter grade.
  - (d) **INTEGRAL WITH RAMP:** Depressed curbing shall not be constructed as an integral part of concrete ramps.
  - (e) **MONOLITHIC:** Existing monolithic curb shall be chiseled off to a line 1½" above gutter grade after which the broken surface shall be finished with a 1:2 Portland Cement Mortar mixture to present a smooth and even surface.
  - (f) **GRANITE OR BLUE STONE:** Where granite or blue stone curbing exists, curb reductions must be made by competent mechanics with proper tools.

## SECTION VII

### SIDEWALK AREA

#### Regulation Driveways

- 7.1 **IMPROVED OR UNIMPROVED AREAS:** That part of the highway extending from curblines to right-of-way line, whether improved or unimproved, is considered and controlled as sidewalk area.
- (a) **IMPROVED AREA:** This is an area where sidewalk may exist or an area that is seeded, sodded, or otherwise ornamentally planted.
  - (b) **UNIMPROVED AREA:** Where entirely unimproved sidewalk area exists, the permittee is required to raise the sidewalk berm eight-inches above the shoulder grade of the highway after which it shall be seeded, sodded, or ornamentally planted with low growing ground cover.
- 7.2 **REQUIREMENTS:** The Department favors the construction of sidewalk, however, such installations are not considered a requisite

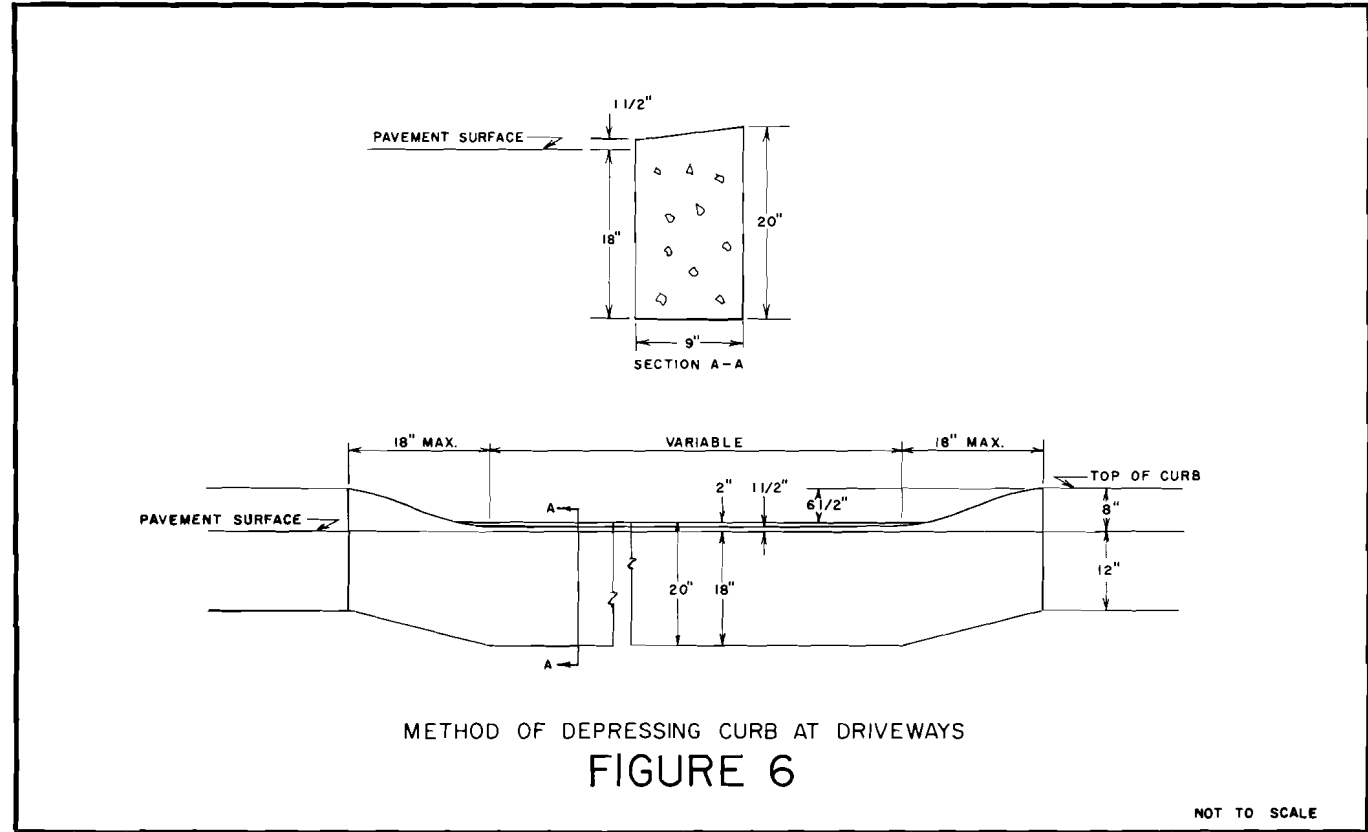


TRANSVERSE JOINTS 1/2" WIDE SHALL BE INSTALLED IN THE CURB 20'-0" APART AND SHALL BE FILLED WITH PREFORMED BITUMINOUS-IMPREGNATED FIBER JOINT FILLER, COMPLYING WITH THE REQUIREMENTS OF A.A.S.H.O. SPEC. M-213, RECESSED 1/4" IN FROM FRONT FACE AND TOP OF CURB.

9" x 20" WHITE CONCRETE VERTICAL CURB

FIGURE 5

15



unless specifically requested by the Department, applicant or required by local ordinance.

- 7.3 **DESCRIPTION:** Sidewalks shall be constructed of portland cement concrete, except if specifically otherwise allowed in the permit, and the subgrade shall be prepared accordingly. Portland cement concrete sidewalk is hereinafter termed concrete sidewalk.
- 7.4 **CONCRETE SIDEWALK:** Sidewalks shall be constructed with Class C, air-entrained concrete.
- (a) **SPECIFICATIONS:** Class C, 1: 2: 4 mix. The concrete proportion shall consist of one part Portland Cement, two parts sand, and four parts crushed stone or washed gravel, and constructed to a thickness of not less than four (4) inches
  - (b) **ALINEMENT AND GRADE:** Alinement and grade is to be determined by that established or existing in area and if need be, through the assistance of a qualified engineer.
  - (c) **TRANSVERSE EXPANSION JOINTS:** Transverse expansion joints  $\frac{1}{2}$ " wide, shall be provided at intervals of not more than 20 feet and filled with prefabricated bituminous cellular type joint filler.
  - (d) **LONGITUDINAL JOINTS:** Longitudinal joints,  $\frac{1}{4}$  inch wide, shall be provided between curbs and abutting sidewalks and shall be filled with premolded bituminous type joint filler.
  - (e) **TRANSVERSE SURFACE GROOVES:** Shall be cut in sidewalk between expansion joints at intervals equal to the sidewalk width.
  - (f) **SLOPE:** The standard slope of sidewalk or sidewalk area shall be  $\frac{1}{4}$  inch per foot rising from the top of standard curb.
  - (g) **TYPE OF FINISH:** The finish shall be made with a wood float, followed by brushing with a wet soft-hair brush to a neat and workmanlike surface. All edges shall be neatly rounded to  $\frac{1}{4}$  inch.

## SECTION VIII

### INSTALLATION OF PIPES

#### Regulation Driveways

- 8.1 **JURISDICTION:** The Transportation Department is only concerned with ditches and construction of drainage that falls within the limits of its jurisdiction or easement.
- 8.2 **PIPES UNDER DRIVEWAYS:** Where ditches exist, pipes of size and material designated by the Department are to be installed beneath drives.
- 8.3 **PIPING ALONG FRONTAGE:** Where ditches exist and conditions are favorable, installation of a continuous pipe of proper size may be permitted.

- (a) **MANHOLES:** Where installation of pipe exceeds three hundred and fifty feet in length, a manhole must be constructed midway between the ends. Installation of such pipe longer than three hundred and fifty feet will not be permitted without intermittent manholes.
- 8.4 **COST:** The Transportation Department will not assume any cost involved in installation of pipes.

## SECTION IX GENERAL RESTRICTIONS

### Regulation Driveways

- 9.1 **RIGHT-OF-WAY ENCROACHMENT:** No part of highway right-of-way is to be used for servicing of vehicles, displays, or to conduct private business. The sidewalk area is to be kept clear of buildings, sales exhibits, signs, parking areas, service equipment and appurtenances thereto. Refer to Page 2 under Section 27: 7-44.1 of "Title 27 Highways."
- 9.2 **TREES AND SHRUBBERY:** Trimming, removal of trees, or shrubbery within highway jurisdiction for clearing the view to signs on private property or for any other reason is not authorized, except as indicated in Reg. D 15.3 (b).
- 9.3 **ADVERTISING SIGNS OR DEVICES:** No advertising signs or devices may be erected on/or overhanging state right-of-way nor may any portion thereof be used for display of merchandise. The Department, therefore, cannot authorize the erection and maintenance of signs on public property other than advisory, directional and regulatory signs required by state laws. (See Reg. D 13.5)
  - (a) All signs erected by the property owner must not be in violation of Section 39:4-183.3 of "Title 39 Motor Vehicles and Traffic Regulation," which states as follows: "No person shall place, maintain, or display upon or in view of any highway, any unauthorized traffic sign, device, or other contrivance which purports to be or is an imitation of or of such a nature as to be mistaken for an official traffic sign or which attempts to direct the movement of traffic which hides from view or interferes with the effectiveness of any official sign and no person shall place or maintain, nor shall any public authority permit upon any highway, any traffic sign or signal bearing thereon or its support, any commercial advertising."
- 9.4 **PROTECTION OF THE TRAVELING PUBLIC:** The permittee shall properly safeguard all work performed under permit and maintain sufficient warning lights, departmental approved signs and safety devices for protection of the traveling public until the project has been completed.

- 9.5 **PROTECTION FROM SUITS:** The permittee shall indemnify and save harmless the State of New Jersey, its officers, employees, and agents against all suits and costs of every name and description and from all damages and injuries including claims allowed by legislature and charged to the Budget of the State Transportation Department.
- 9.6 **PROTECTION OF STRUCTURES AND FACILITIES:** Work shall be so conducted that there shall be no interference with any Departmental structure or facility, on, over, or under the highway, unless with permission of the Department.
- 9.7 **EXISTING CATCH BASINS:** Unless curbing or curb returns are installed, the Department will not approve construction of driveways nearer than five feet to inlets or catch basins.
- 9.8 **DRAINAGE RIGHTS:** Where property adjacent to highway is to be filled to highway grade, the owner may be required to make provision, at his own expense, for disposition of highway drainage by installing such pipe of adequate size and material, inlets, catch basins, manholes, headwalls, and ditches as may be necessary to protect the state's drainage rights. (Interference with drainage installations must be avoided. The existing cross-section and drainage of highways shall not be disturbed. The longitudinal flow of water along the gutter line must not be interrupted, and it shall be the responsibility of the owner to make adequate provision for all transverse, lateral and longitudinal drainage affecting his construction.)
- 9.9 **RESTRICTION OF NEW PAVEMENT:** The five-year restriction of newly constructed highways does not apply to construction of access driveways.
- 9.10 **CONSTRUCTION WITHIN RIGHT-OF-WAY:** The Transportation Department will not authorize construction work within the limits of right-of-way which will adversely affect the stability, appearance, or designed function of the highway itself, or any of its component or auxiliary structures.
- 9.11 **LIGHTING:** All lighting equipment for roadside establishments must be located off highway right-of-way and present no hazard to the traveling public.
- 9.12 **ALTERATION TO DRIVEWAY:** No alteration or addition shall be made to any driveway within state right-of-way, without first securing written permission from the Department.

## SECTION X

### NUMBER AND ARRANGEMENT OF DRIVEWAYS

#### Regulation Driveways

- 10.1 **BASIC PRINCIPLES:** Driveways should be so located as to avoid

undue interference with, or restriction of the free movement of normal highway traffic so that areas of traffic congestion will not be created. In accordance with this principle, driveways should be constructed where highway alignment and profile are favorable; i.e., where there are no sharp curves, or steep grades, and where sight distance in conjunction with driveway access would be adequate for safe traffic operation. Driveway locations should be avoided within intersections, rotaries, and interchanges. Also to be avoided are locations that would interfere with the placement and proper functioning of highway signs, signals, lighting, or other devices that affect traffic operations.

- 10.2 **FRONTAGES LESS THAN ONE HUNDRED FEET:** Property having a frontage of less than one hundred feet (100 ft.) should have only one driveway.
- 10.3 **FRONTAGES OF ONE HUNDRED FEET OR MORE:** More than two driveways may be provided for any single property tract or business establishment. Where the frontage is sufficient, additional driveways may be permitted.
- 10.4 **ARRANGEMENT OF TWO OR MORE DRIVEWAYS:** Driveway must be positioned to clear the extended property lines by a minimum of five (5) feet. Where two driveways are provided for one frontage, the distance between must not be less than 25 feet.
- 10.5 **CORNER PROPERTY:** At an intersection, driveways connecting each highway with the corner property may be permitted when essential to the conduct of business on the corner tract, provided such driveways comply with regulations. The Department recommends that the corner clearance be more than, but not less than 10 feet.
- 10.6 **JOINT DRIVEWAYS:** Refer to Reg. D 15.5.

## SECTION XI

### DRIVEWAY SURFACING

#### Regulation Driveways

- 11.1 **DRIVEWAY SURFACING:** Driveways should be appropriately surfaced. The Department of Transportation is only concerned with that portion within the limits of its right-of-way. There is no standard type of surfacing that must be used. The driveway approach should be constructed of a permanent type pavement and similarly surfaced to the right-of-way line. Gravel surfacing may be suitable in some areas. Rural residential and field driveways may not require surfacing.
- 11.2 **PAVING AT CURBLINE:** Paving of driveways is not to extend beyond the curbline into the shoulder area, unless by specific

approval of the Department. In any event, the existing grade of the highway shoulder must be maintained at all times.

- 11.3 **CONCRETE PAVEMENT:** Concrete driveways should be constructed of Class B concrete, six (6) inches thick.
- 11.4 **BITUMINOUS PAVEMENT:** When constructing a bituminous concrete driveway, that portion from curblines to right-of-way line should not be inferior to four (4) inches of macadam base with a bituminous concrete surface, two (2) inches thick.

## SECTION XII CONTROL DIMENSIONS

### Regulation Driveways

- 12.1 **EDGE CLEARANCE (E):** All portions of the driveway should be within the extended property lines. The normal edge clearance should not be less than 5 feet i.e., measured from the said property line, along the curblines to beginning of curblines opening.
- 12.2 **CURBLINE OPENING (C.O.):**
  - (a) **RESIDENTIAL:**  
Minimum of 12 feet  
Maximum of 30 feet
  - (b) **COMMERCIAL:**  
Minimum of 24 feet  
Maximum of 50 feet
- 12.3 **DRIVEWAY WIDTH (W):**
  - (a) **RESIDENTIAL:**  
Minimum of 8 feet  
Maximum of 26 feet
  - (b) **COMMERCIAL:**
    - 1. **ONE-WAY OPERATION:** Entrance or Exit 20-34 feet maximum.
    - 2. **TWO-WAY OPERATION:** 20-46 feet maximum.
- 12.4 **DRIVEWAY ANGLE (Y):**
  - (a) **ONE-WAY OPERATION:** Driveways used by vehicles in one direction of travel on highway (right turn only): 45 degrees minimum.
  - (b) **TWO-WAY OPERATION:** As near 90 degrees as site conditions will permit; normal minimum 60 degrees.
- 12.5 **RADIUS OF CURVATURE (R) OR (U):**  
**RESIDENTIAL:** Maximum — 10 feet  
**COMMERCIAL:** Maximum — 15 feet  
Special consideration will be given to unusual cases.

- 12.6 **DISTANCE BETWEEN DRIVEWAYS:**  
**RESIDENTIAL:** 25 feet minimum  
**COMMERCIAL:** 25 feet minimum  
Drives must be separated by a safetyzone of a length satisfactory to the Department and extend from the curb or shoulder line to the property line. The area must be raised 6 inches above the surface of the adjacent drives and seeded, sodded, or otherwise improved in accordance with regulations.
- 12.7 **SETBACK: (G):**  
(a) **REQUIREMENTS:** The Department of Transportation has no jurisdiction over areas outside right-of-way lines, however, it is recommended that the following setbacks be considered.  
(b) **GASOLINE PUMPS:** Pump islands should be 15 feet or more outside the right-of-way line.  
(c) **GASOLINE SERVICE STATIONS AND SMALL BUSINESSES:** 40 feet minimum.  
(d) **LARGE RESTAURANTS AND BUSINESSES:** 50 feet minimum.  
(e) The Department urges an adequate setback from the property line for restaurants, roadstands, and other structures to provide off-street parking.
- 12.8 **CORNER CLEARANCE:**  
(a) **MINIMUM:** 10 feet. See figure 4. This standard may be increased or decreased to fit field conditions.  
(b) **WHERE TRAFFIC SIGNALS EXIST:** Where there are traffic signals at the intersection, the desirable clearance should be two or more times the minimum corner clearance.
- 12.9 **DRIVEWAY ALIGNMENT AND PROFILE:** Single driveways should be positioned at right angles to the roadway. Where two driveways are used on one frontage and they are to be used for access to and from both directions of travel on the highway, each driveway may be placed at an angle other than a right angle with the roadway edge but not less than 45 degrees.  
(a) **ILLUSTRATION:** See figure 8 on Page 28. Driveway profile controls are shown in detail.

### SECTION XIII

## RELOCATION OR REMOVAL OF STRUCTURES WITHIN THE LIMITS OF DRIVEWAYS

### Regulation Driveways

- 13.1 **JURISDICTION OF STRUCTURES:** The Department's interest is in all structures within the limits of its right-of-way and those covered by easement.

- 13.2 **REMOVAL OF CURB:** Removal of curb is not authorized except in accordance with Section VI, Curb.
- 13.3 **RELOCATION OF DRAINAGE STRUCTURES:** Where storm sewers, highway grades, and other conditions are favorable, permission may be obtained for the relocation of an inlet. All work will be at the expense of the permittee and shall be constructed in accordance with New Jersey Department of Transportation Standards and Specifications under Departmental supervision. Refer to Reg. D 9.6 and 9.8.
- 13.4 **REMOVAL OF GUARD RAIL:** Upon written request, guard rail will be removed by the Transportation Department Forces, providing the applicant has completed the fill behind the guard rail to the satisfaction of the Department.
- 13.5 **RELOCATION OF OFFICIAL SIGNS:** The Department will arrange for the relocation of advisory, directional and regulatory signs upon request at its expense, providing an equally satisfactory location can be found.
- 13.6 **RELOCATION OF DEPARTMENTAL ELECTRICAL FACILITIES:**
  - (a) **DEPARTMENTAL STRUCTURES:** The Department may permit the relocation of state-owned electrical facilities located within the site of a proposed drive, providing a new location can be found, satisfactory to the Transportation Department. This applies also to pavement detectors, pullboxes, conduits, and other constituent parts; relocation cost to be assumed by applicant.
  - (b) **COUNTY OR MUNICIPAL STRUCTURES:** Where structures are owned by a county or municipality, said county or municipal permission must be obtained before access permission is requested.
- 13.7 **RELOCATION OF UTILITY POLES:** Permission may be granted for construction of a driveway at a site which includes a utility pole. However, relocation of such utility property must be arranged by the permittee with the owning utility company or municipality. Should a pole have attached to it service connections for state owned facilities, the department will relocate the service. The relocation cost to be assumed by applicant.
- 13.8 **RELOCATION OF HIGHWAY LIGHTING POLES:** Relocation of utility poles carrying units of the Department's lighting system usually cannot be arranged. These are placed in accordance with a carefully designed spacing pattern. However, should a new design be necessary, all costs will be assumed by applicant.
- 13.9 **DEPARTMENTAL ELECTRICAL CABLES AND CONDUIT UNDER DRIVES:** At locations on highways where metal pole lighting exists, electrical conduit or direct buried high voltage cables are located adjacent to inside of curbing, at a depth of approximately 18" below top of curb. Extreme care must be exercised

not to damage conduit or cables during removal of curbing and construction of driveways. During construction, it will be necessary to protect cables by encasing them in fiber conduit with an envelope of concrete as shown in Figure 7 on Page 24. The owner or contractor shall notify the District Electrical Supervisor at Least three working days prior to any excavation adjacent to curbing.

- 13.10 **RELOCATION OF A FIRE HYDRANT:** When a fire hydrant exists within the area of an approved location, same procedure in Reg. D 13.7 shall be followed.

## SECTION XIV

### MATERIALS AND WORKMANSHIP

#### Regulation Driveways

- 14.1 **APPROVAL:** Materials and workmanship used in construction within right-of-way of a highway are subject to inspection and approval of the Department.
- (a) **WORKMANSHIP:** The resultant work, as far as is practicable, must conform in appearance to similar Departmental construction.
- (b) **MATERIALS:** Unless otherwise specified in the foregoing regulations, materials shall conform to the Standard Specifications of the New Jersey Department of Transportation.
- (c) **INSPECTION:** If the work is deemed of sufficient importance, the Department may assign an inspector to the job whose time and expenses may be charged to the permittee.
- 14.2 **COST:** The cost of construction work and material will be entirely at the permittee's expense. The Department of Transportation will not share in any expense whatsoever or do any construction work pertaining to access driveways.
- (a) **EXCEPTION:** Refer to Reg. 15.4 (b).

## SECTION XV

### GENERAL INFORMATION

#### Regulation Driveways

- 15.1 **FREEWAYS, PARKWAYS, AND INTERSTATE ROUTES:** These rules and regulations do not pertain to controlled access highways, such as Freeways, Parkways, and Interstate routes where direct access is prohibited by law.
- 15.2 **EXPENDITURES:** The Department will not expend public funds in assisting abutting property owners to obtain access to the



highway, except as indicated in Reg. D 15.4 (b).

15.3 **LANDSCAPING:**

- (a) **GROUND COVER:** Only very low growing ground cover may be maintained within sidewalk area, subject to Department approval. Plantings shall not interfere with sight distance.
- (b) **TREES:** The Department may authorize removal or relocation of trees or landscaping material which are within proposed driveway locations, providing reasonable access cannot otherwise be obtained. The Department will consider trimming or removal for purposes of safety visibility between a driveway and highway upon written request. The Department may approve certain trimming provided the appearance or health of the planting is not affected. Such work will be done by Departmental forces.
- (c) **REMOVAL OR RELOCATION:** The Department reserves the right to require the relocation of material which may be disturbed or substitution of other suitable material if such action is considered desirable.

15.4 **POLICY GOVERNING THE CONSTRUCTION OF DRIVEWAYS:**

- (a) **EXISTING HIGHWAYS:** The construction and maintenance of driveways shall be the responsibility of the owner of the abutting property.
- (b) **HIGHWAYS UNDER CONSTRUCTION:** On new construction or betterment projects, driveways that serve residential or business establishments that have been disturbed or must be redesigned will be restored or reconstructed by the Department without cost to property owner upon approval of the Department.
  - (1) **CURB DEPRESSIONS:** If new or additional curb is to be constructed within the scope of work, the Department will construct curb depressions upon request. Such request will be subject to Section III, Permit Provisions, Page 2.

15.5 **COMMON DRIVES:** When agreeable between two adjoining property owners, a joint or common driveway may be approved.

- (a) **PROCEDURE:** Application for access permit (Form MT-32) must be filed according to Section III endorsed by each property owner.

15.6 **DRIVE-IN THEATER ENTRANCES:** Such requests require special study. Refer to Part XIX, Page 44.

15.7 **SURPLUS RIGHT-OF-WAY:** Driveways cannot be authorized which cross or otherwise encroach upon state property, or the frontage thereof, which is held as surplus right-of-way and which may be subject to sale.

15.8 **ACCELERATION AND DECELERATION LANES:** These are explained on Page 48-50 shown on sketches 17 and 18. Such

requests require special study, refer to Section XIX, Page 44.

- 15.9 **INTERNAL PARKING:** In planning roadside enterprises it becomes imperative that properties to be developed should be adequate in size to provide off the road parking facilities.

Traffic surveys indicate that the number of parking spaces available should equal about 60% of the number of patrons at peak business hours. The average passenger car requires a space of about 9' x 18' plus an aisle width of about 25' between rows of cars. If parking space is required for heavy commercial vehicles, a separate parking area of adequate size should be provided.

## SECTION XVI

### LOCAL ORDINANCES AND REGULATIONS

#### Regulation Driveways

- 16.1 **SETBACK AND DRIVEWAY WIDTH:** The New Jersey Department of Transportation will respect local building, zoning or setback, ordinances, rules and regulations. Permits will not be issued which in any way might violate the letter, spirit or intent of such ordinances and regulations.

## SECTION XVII

### SPECIAL CONDITIONS

#### Regulation Driveway

- 17.1 **CONDITIONS:** The State Department of Transportation may impose special conditions if necessary, when issuing permits. These will be included as a condition of the permit and will also be noted on approved plans.
- 17.2 **GUARANTEE:** The Department shall reserve the right to demand from the applicant as a condition of any permit, a bond or certified check in an amount sufficient to guarantee or insure proper maintenance or restoration of the area disturbed. If it becomes necessary that Department forces, for any reason, are required to make repairs, the cost of such work shall be deducted from the principal and the remainder, if any, shall be returned after the project has been completed and accepted. If the amount of the guarantee is less than the cost of the additional work, the applicant shall be billed for the balance due.
- 17.3 **SIGNALIZED INTERSECTION:** The construction of a driveway at a signalized intersection usually necessitates for proper operating

of the facility, the installation of additional signal equipment. The Department shall determine the additional facilities required. All equipment shall be installed in accordance with the New Jersey Department of Transportation Standards and Specifications under Department supervision. At the request of the permittee, the Department will perform the signal modification. The cost of the signal modification work and all electrical equipment will be entirely at the permittee's expense.

## SECTION XVIII

### ILLUSTRATIONS OF STANDARD DRIVEWAYS

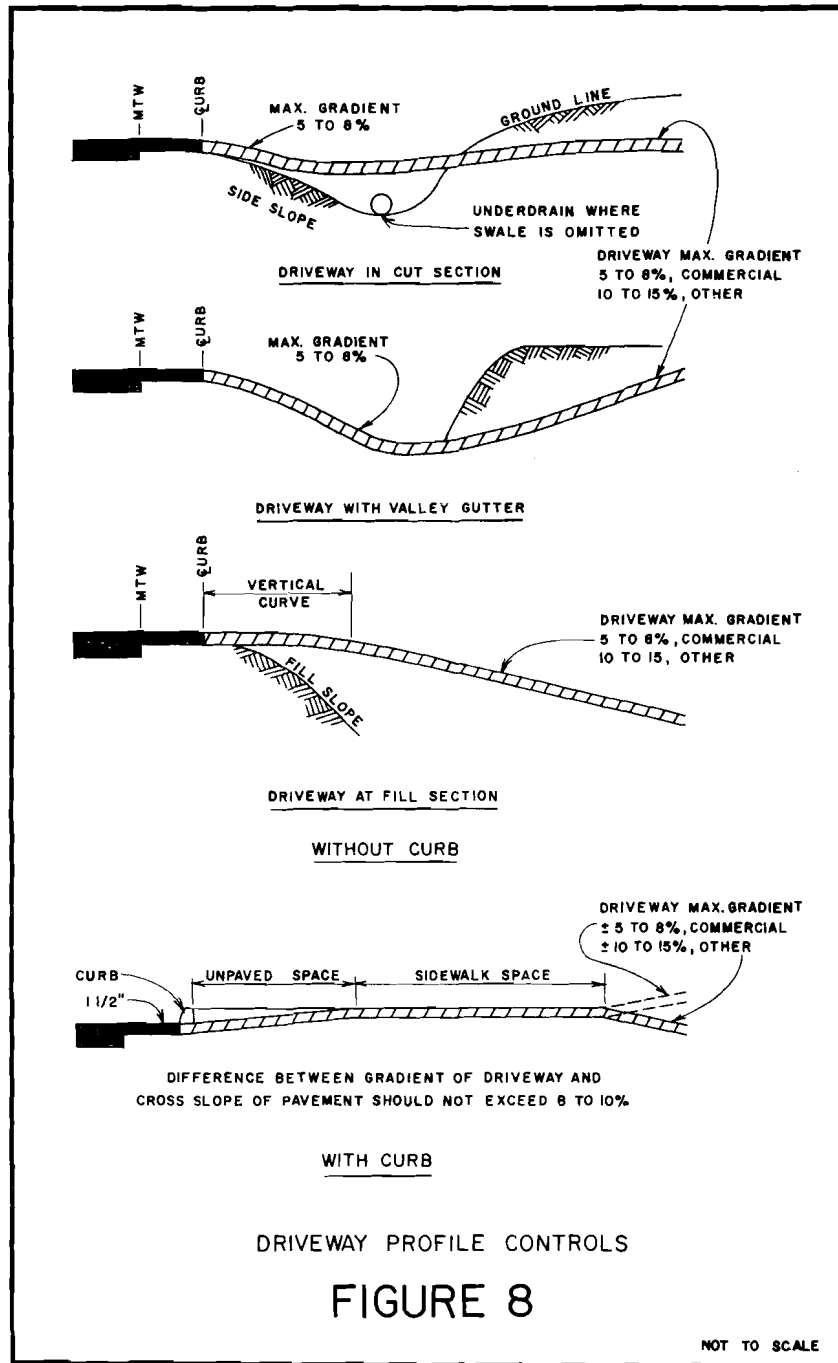
#### Regulation Driveway

- 18.1 **TERMS:** The sketches in this section, abbreviations used and their meaning, shall be interpreted as follows:

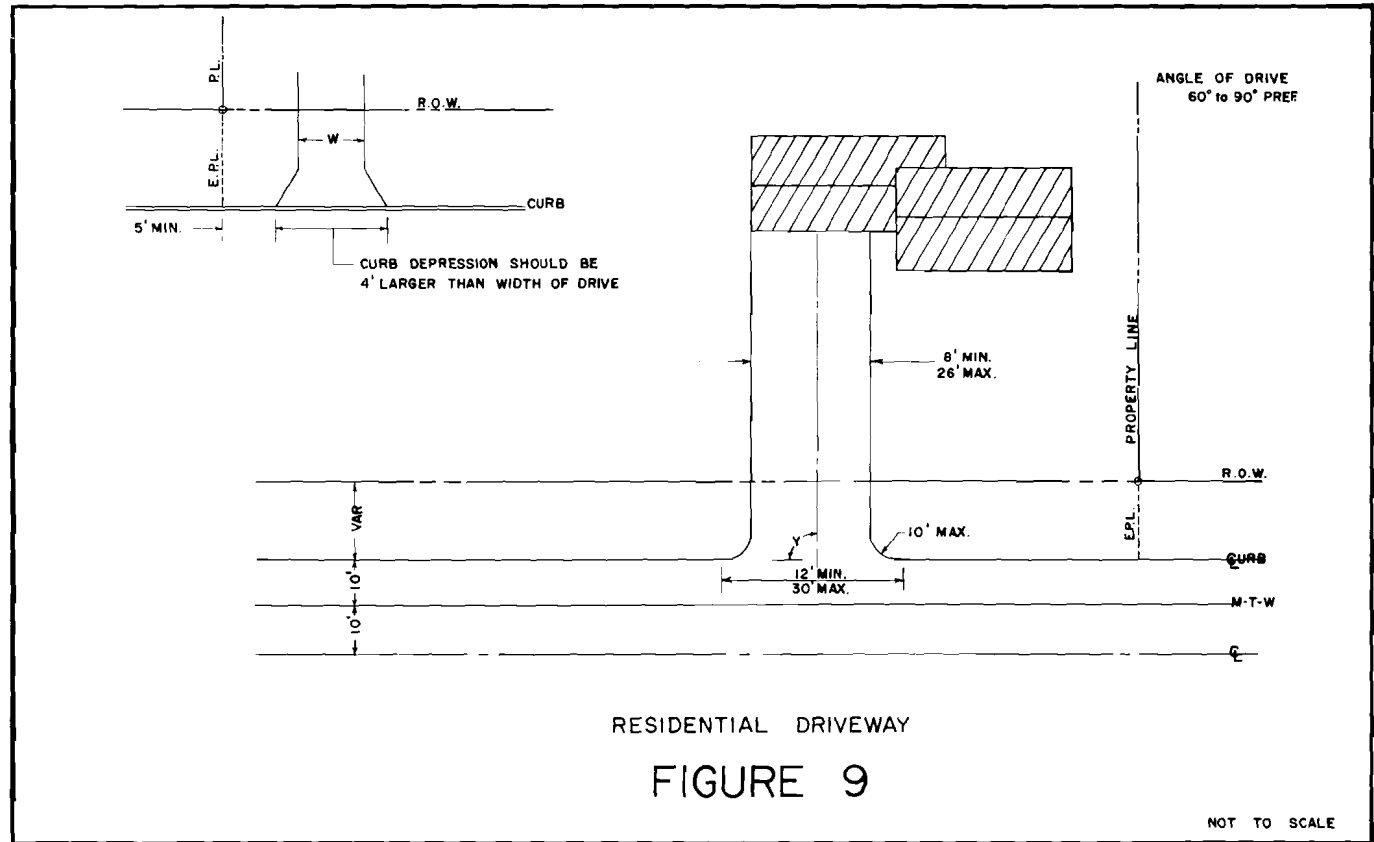
P. L.	—	Property Line
R.	—	Radius
⊕		Centerline of Highway
E. P. L.	—	Extended Property Line
M. T. W.	—	Edge of Main-Traveled Way
R. O. W.	—	Right-of-Way
⊕ <sub>curb</sub>	—	Curbline or Gutterline
S. W.	—	Sidewalk
VAR.	—	Variable Width

- 18.2 **SKETCHES AND LAYOUTS:** A series of diagrammatic sketches and typical layouts to illustrate regulations and suggestions for likely cases on two lane highways (no divider) are shown on the following pages.

When applying for a permit, consideration should be given to these designs, and the access be constructed accordingly.

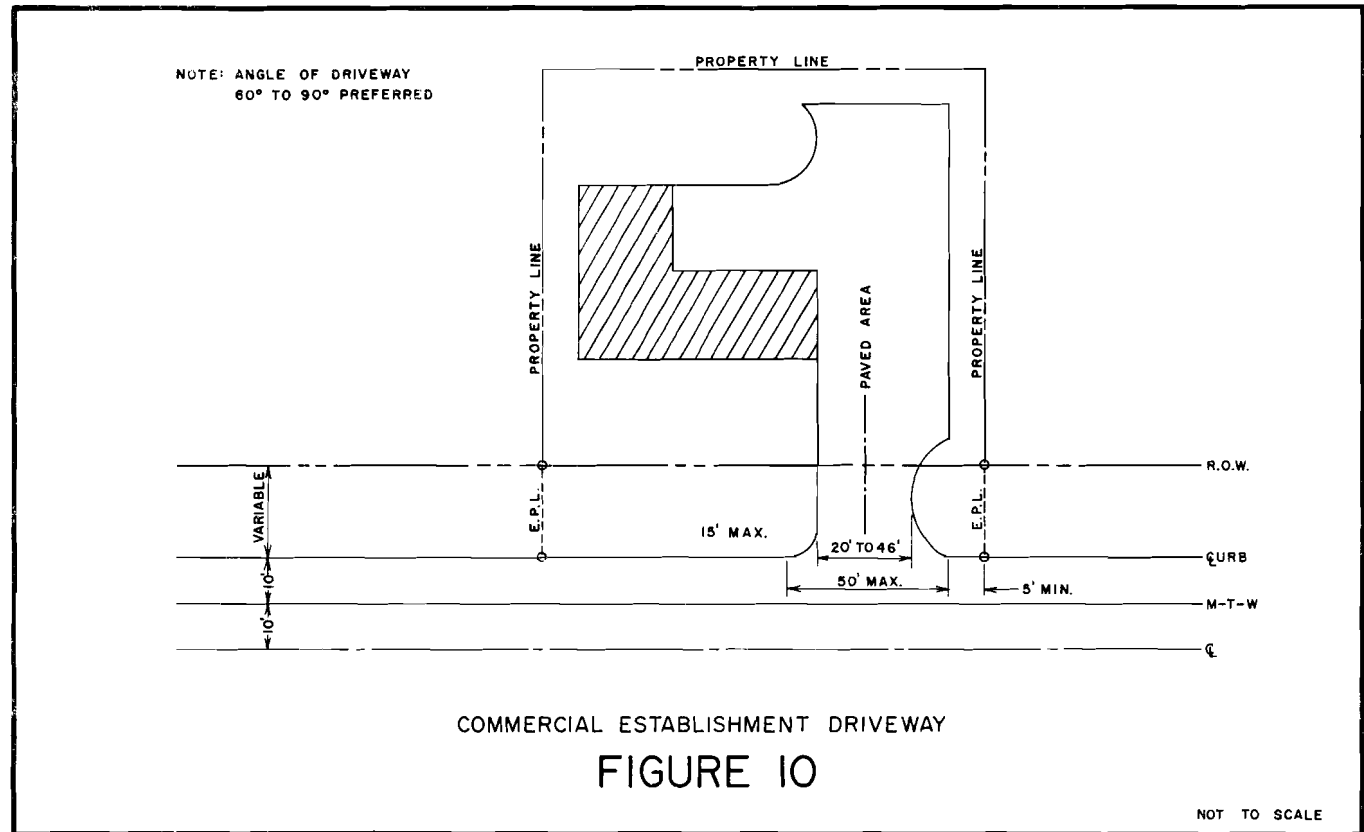


**FIGURE 8: DRIVEWAY PROFILE CONTROLS:** This sketch shows typical driveway profile controls. The use of a swale or pipe underdrain for proper drainage of uncurbed portions of highways is indicated. The bottom profile shows a driveway sloping upward to the sidewalk to assure proper drainage. Beyond the sidewalk the driveway may slope either upward or downward depending upon the topography at the site. Where curbs are used along the roadway and sidewalks are provided or contemplated, the gradient of the driveway usually should fit the plane of the sidewalk. If the difference in elevation of the gutter and the sidewalk is such that this is not practicable, then the sidewalk should be lowered to provide a suitable gradient for the driveway. In such case, the surface of the sidewalk should be sloped gently from either side of the driveway. Vertical curves on driveways should be flat enough to prevent dragging of vehicle undercarriage.



**FIGURE 9: RESIDENTIAL DRIVEWAY:** Figure 9 shows a single residential driveway along a two-lane highway. In such case, the frontage usually is not a governing factor but edge clearance must be controlled. In cases where the property frontage is limited, the edge clearance becomes a prime factor.

Where conditions permit, the Department prefers the curbline opening minimum to be twenty-four (24) feet. In all cases, the overall dimension at the curbline shall not exceed thirty (30) feet, measured from the extreme outer edges of the radii. If curbing exists, or is to be constructed, the curb depression shall not be less than the minimum of twelve (12) feet or more than the maximum of thirty (30) feet. Normally the curb depression should be four (4) feet wider than the width of driveway. From this point the drive should taper inward to the width of driveway at the sidewalk.

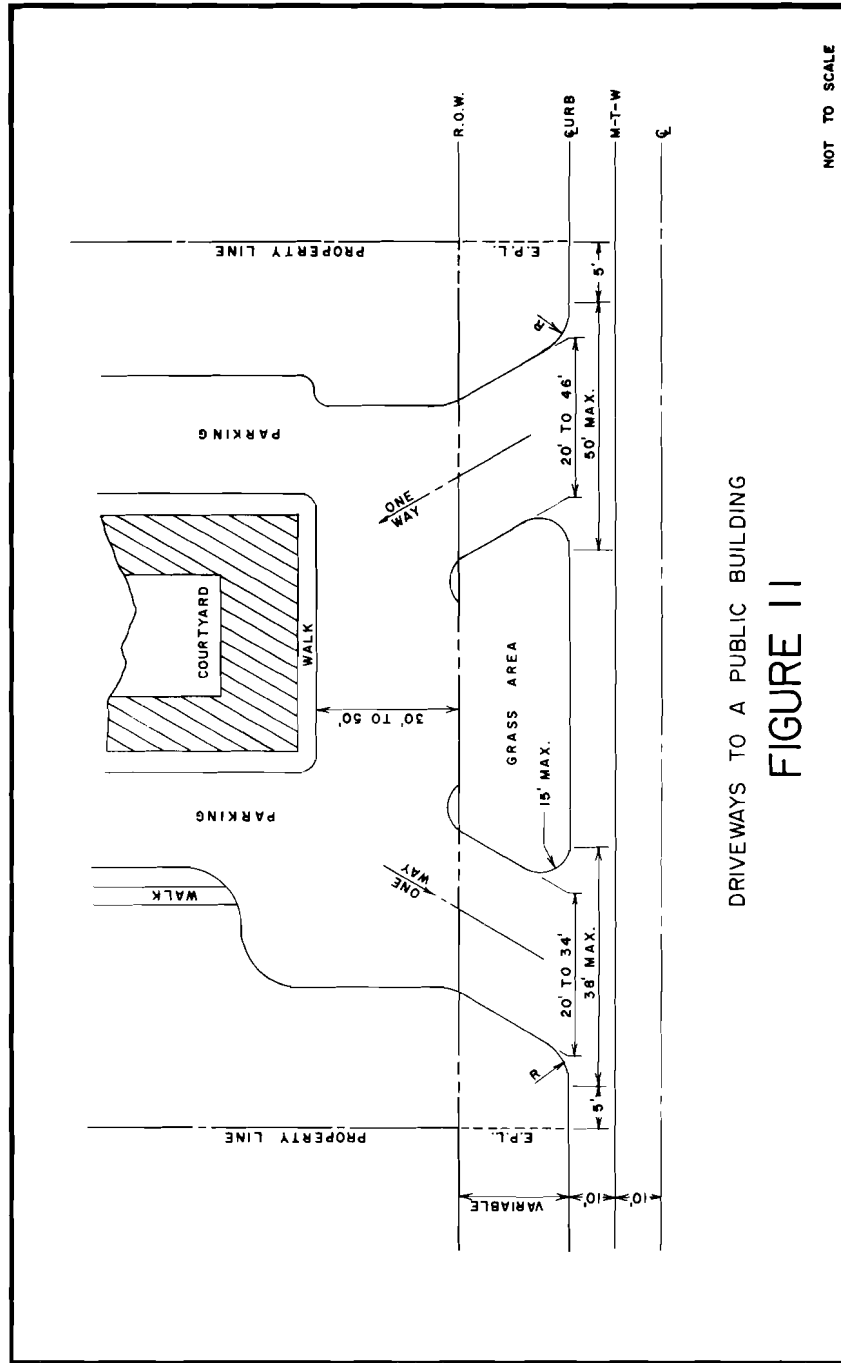


**FIGURE 10: COMMERCIAL DRIVEWAY:** Figure 10 shows a single driveway connection to a commercial establishment along a two-lane undivided highway. While a small development area is shown, the same treatment would apply for a much larger site.

The overall opening at the curblines should not exceed fifty (50) feet, measured from the extreme outer edges of the radii.

If curbing exists or is to be constructed, the minimum depression should not be less than twenty-four (24) or more than the maximum of fifty (50) feet.

A minimum of five (5) feet or more should be used as the edge clearance.



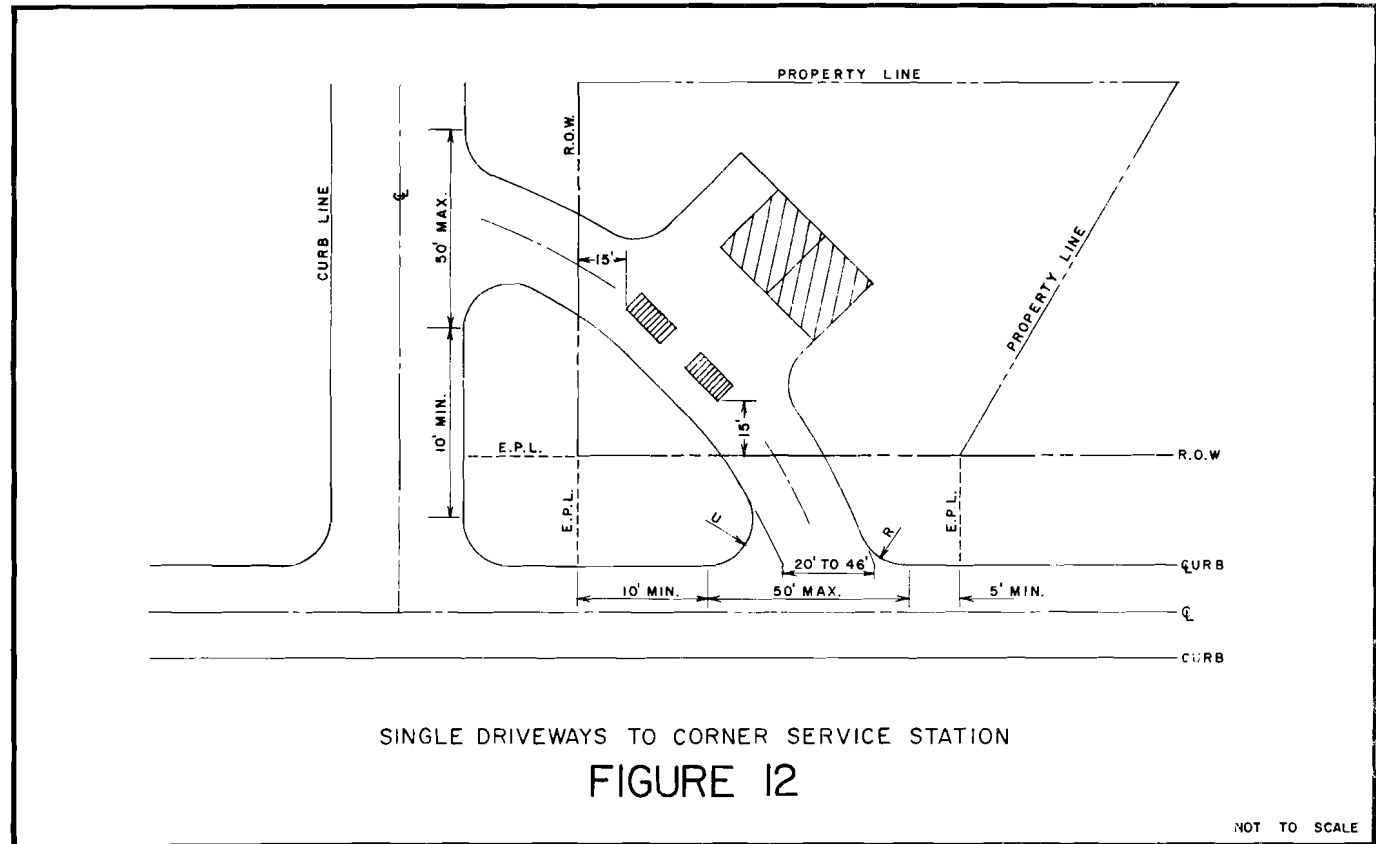
**FIGURE 11: DRIVEWAYS TO A PUBLIC BUILDING:** Figure 11 shows two driveways connecting to a sizeable roadside development along an undivided highway. The driveways are planned for one-way use to fit the internal circulation pattern. This pattern would be applicable for a public building as shown, or a shopping center, factory, motel, or the like.

The setback from the right-of-way line to the building should be from 30 feet to 50 feet, depending upon the parking situation.

A minimum of five (5) feet or more should be used as the edge clearance.

The angles of the driveway should not be less than the minimum of 60 degrees.

The overall dimension of the entrance at the curblines should not exceed fifty (50) feet whether curbed or not. The exit driveway opening should be approximately three-quarters ( $\frac{3}{4}$ ) of the entrance opening.



SINGLE DRIVEWAYS TO CORNER SERVICE STATION

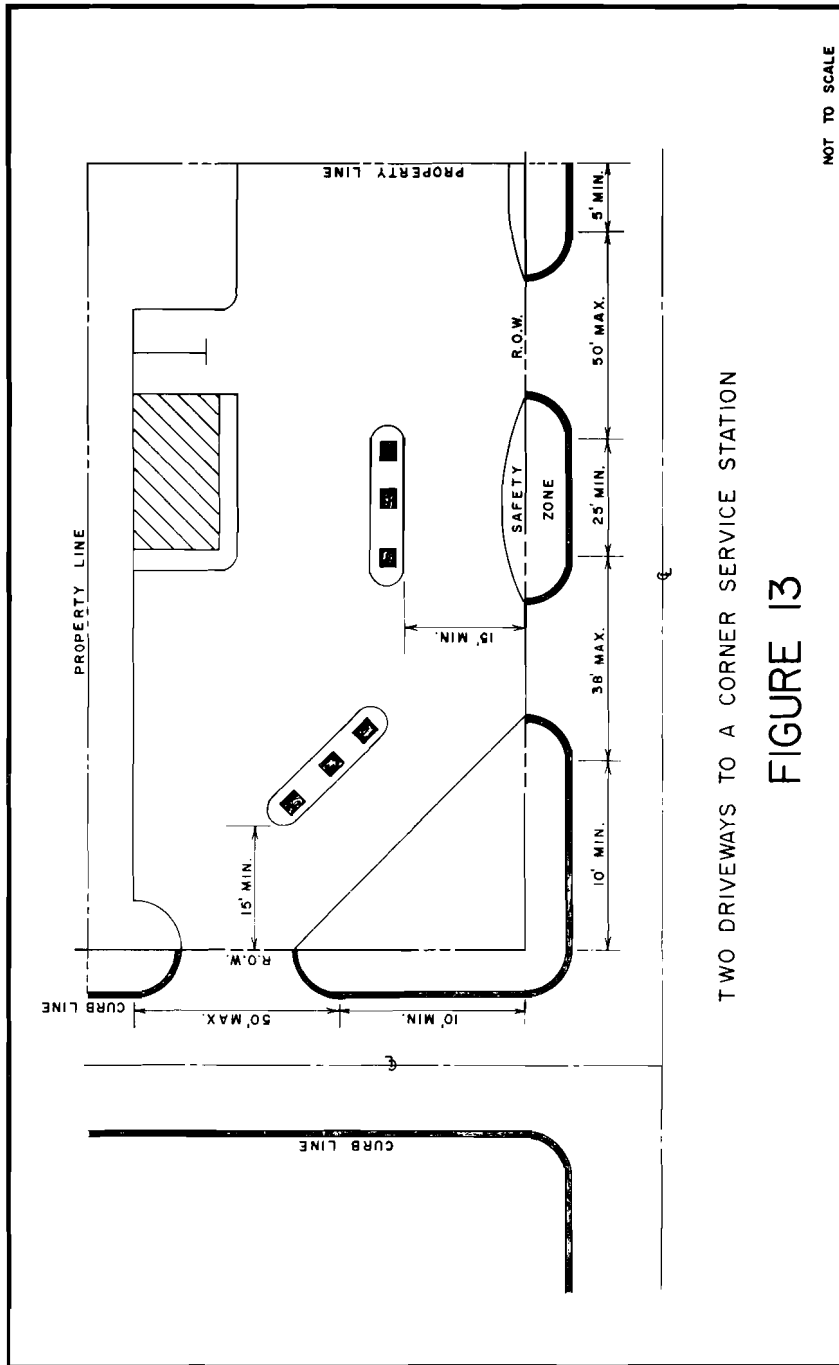
FIGURE 12

NOT TO SCALE

**FIGURE 12: SINGLE DRIVEWAYS TO A CORNER SERVICE STATION:**

Figure 12 shows a corner service station at the intersection of two undivided highways. There is a single driveway to each highway, constructed on an angle preferably of 60 degrees. Note the minimum corner clearance of ten (10) feet. The overall opening width at the curbline should not exceed fifty (50) feet, measured from the extreme outside edges of the radii. If curbing exists or is to be constructed, the depression should not exceed fifty (50) feet.

The setback from the right-of-way lines to the nearest corners of the pump islands should not be less than the minimum of fifteen (15) feet.



TWO DRIVEWAYS TO A CORNER SERVICE STATION

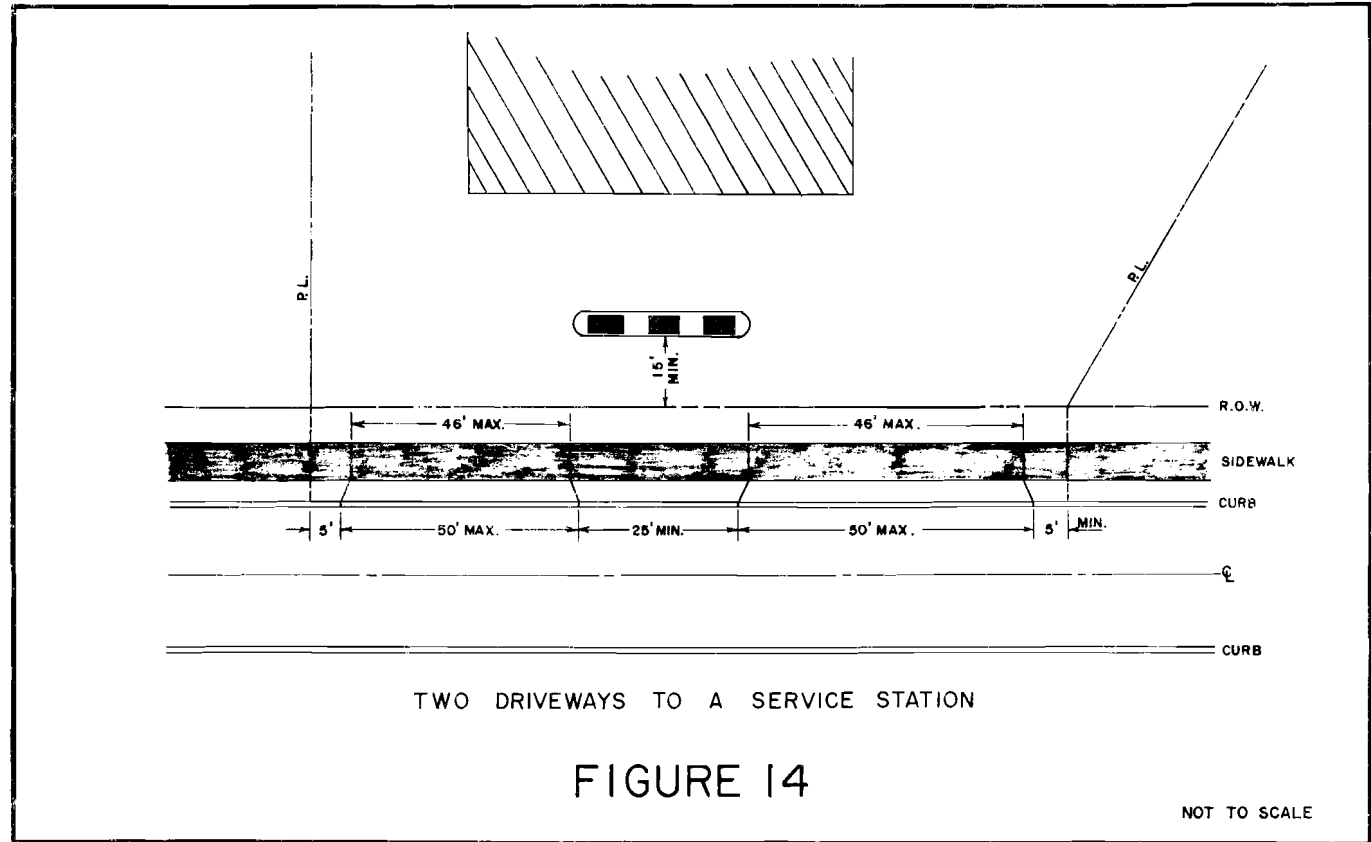
FIGURE 13

NOT TO SCALE

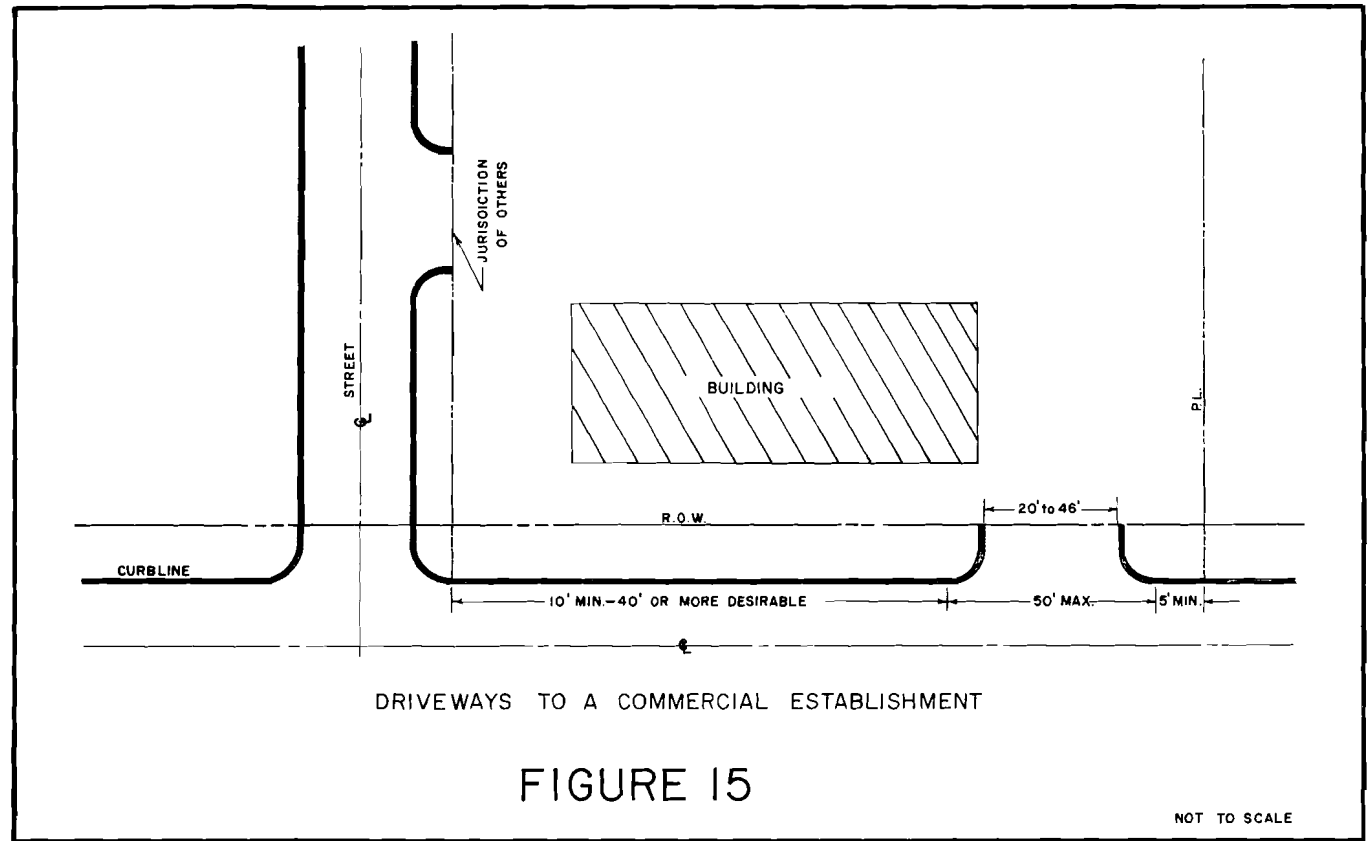
**FIGURE 13: TWO DRIVEWAYS TO A CORNER SERVICE STATION:** This sketch shows two driveways on an undivided highway. They should be directional, but in all cases this might not be feasible. The edge clearance and radius minimum have been reduced to meet existing conditions. We must abide by the minimum safety zone dimension of twenty-five (25) feet. The overall maximum opening at the curblines is fifty (50) feet. If both drives are to be used as entrances and exits, drives should then have the same width openings. If drives are set up as directional drives, the one used as an exit should only be approximately three-quarters ( $\frac{3}{4}$ ) that of the entrance opening.

The setback from the right-of-way lines to the pump island should not be less than fifteen (15) feet.

40



**FIGURE 14: TWO DRIVEWAYS TO A SERVICE STATION:** Figure 14 shows two driveways going into a service station or other roadside business. Usually urban conditions, such as curbed roadway, sidewalks, and limited frontage exist. For such cases, the driveway has no element of length along the highway; primarily it is a ramp pavement from curblines to business area or the right-of-way line. Often a sidewalk is crossed, affecting the profile condition. Functional utility of the driveway largely depends upon the width of opening at the curblines. Edge clearances are important since similar driveways may be necessary on adjacent properties. Curb depressions should not exceed fifty (50) feet in length.



**FIGURE 15: DRIVEWAYS TO A CORNER COMMERCIAL ESTABLISHMENT:** Figure 15 shows driveway connections to a commercial or industrial establishment in an urban or suburban area. There is a single entrance (50) feet maximum curbline opening from the main highway and a secondary entrance from the side street. A curbed section is shown, and there may or may not be sidewalks. The corner clearance should be greater than the suggested ten (10) foot, if at all possible.

Since the secondary drive on the side street is located beyond the state's right-of-way line, it does not fall under the Department's jurisdiction.

**SECTION XIX**  
**CONDITIONS FOR**  
**HIGH TRAFFIC VOLUME GENERATORS**

**Regulation Driveways**

- 19.1 **STATEMENT TO ACCOMPANY APPLICATION:** In order to obtain consideration of requests for such special driveways, the applicant must submit a statement supporting his request setting forth an estimate of the number of cars which will enter and leave the highway and the approximate hour or hours at which the maximum movement will occur and the willingness to meet all expenses in connection with proposed construction within the State's right-of-way.
- 19.2 **PLANS:**  
Six copies of plans shall be submitted for approval, showing the following:
- (a) Width, arrangement, and grade of the traffic lanes of the driveway as related to the width and arrangement of traffic lanes on the State Highway.
  - (b) Location, length, and other details of Speed Change lanes (acceleration, deceleration, or left turn slots) if such facilities are proposed.
  - (c) Plans should be submitted to a scale no greater than 50 feet to 1 inch, preferably 30 feet to 1 inch, using an engineer's scale.
  - (d) Internal Traffic pattern and parking facilities.
  - (e) Changes in location of driveway facilities if such exist.
  - (f) Type of pavement proposed to be constructed.
  - (g) Plans must be fully dimensioned as to the curb radii, right-of-way and lateral property lines, width of traffic lanes, dimension of center and channelizing islands and all other data necessary for complete working plans.
- 19.3 **SPECIFICATIONS:**  
Pavement and other construction within the highway right-of-way must conform to New Jersey Department of Transportation Standard Specifications. Standard white curb must be provided defining edge of all traffic lanes or shoulders.

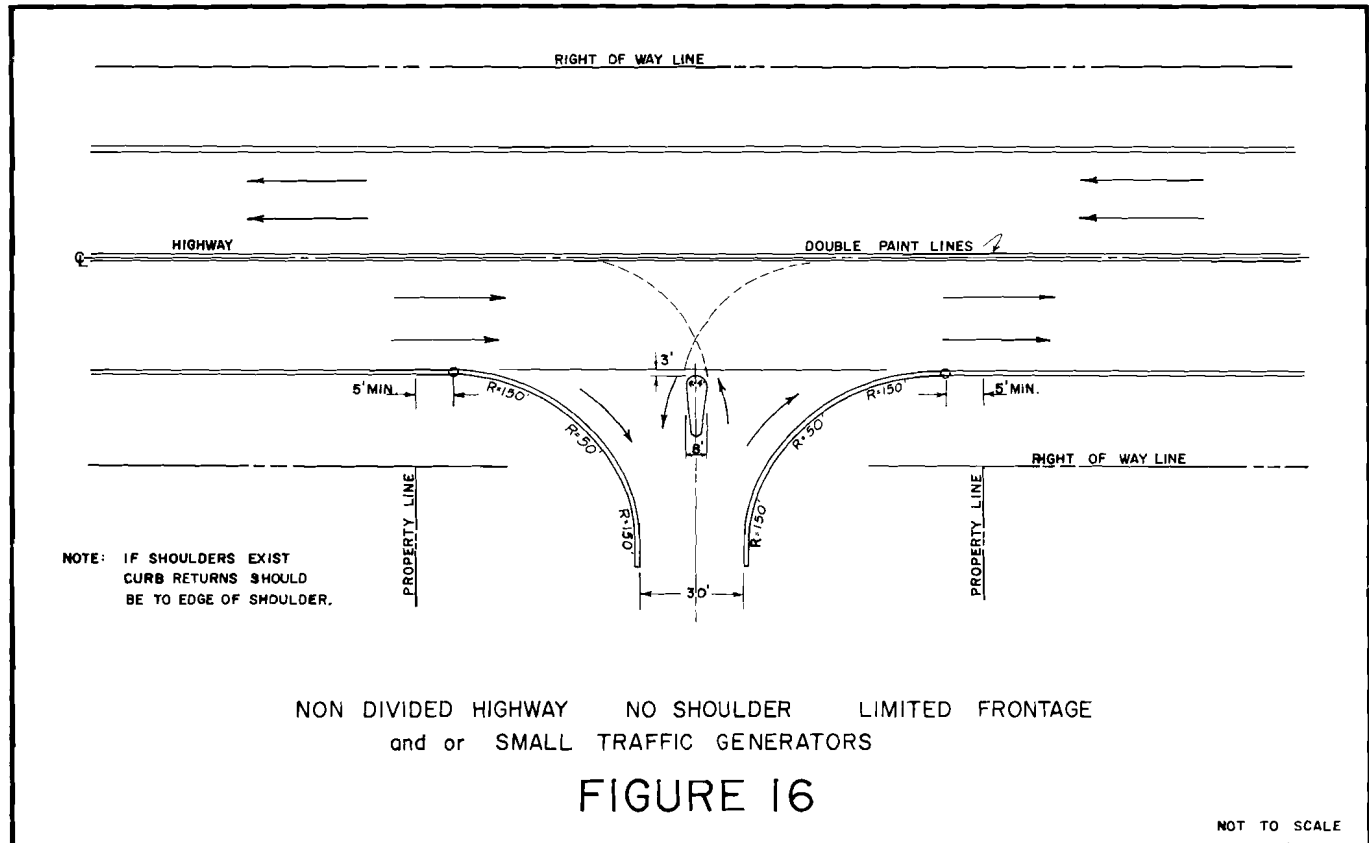
**SECTION XX**  
**COMPLEX DRIVEWAY DESIGNS**

The following is a series of diagrammatic sketches and layouts to illustrate and suggest geometrical designs for driveways where large volumes of traffic are anticipated.

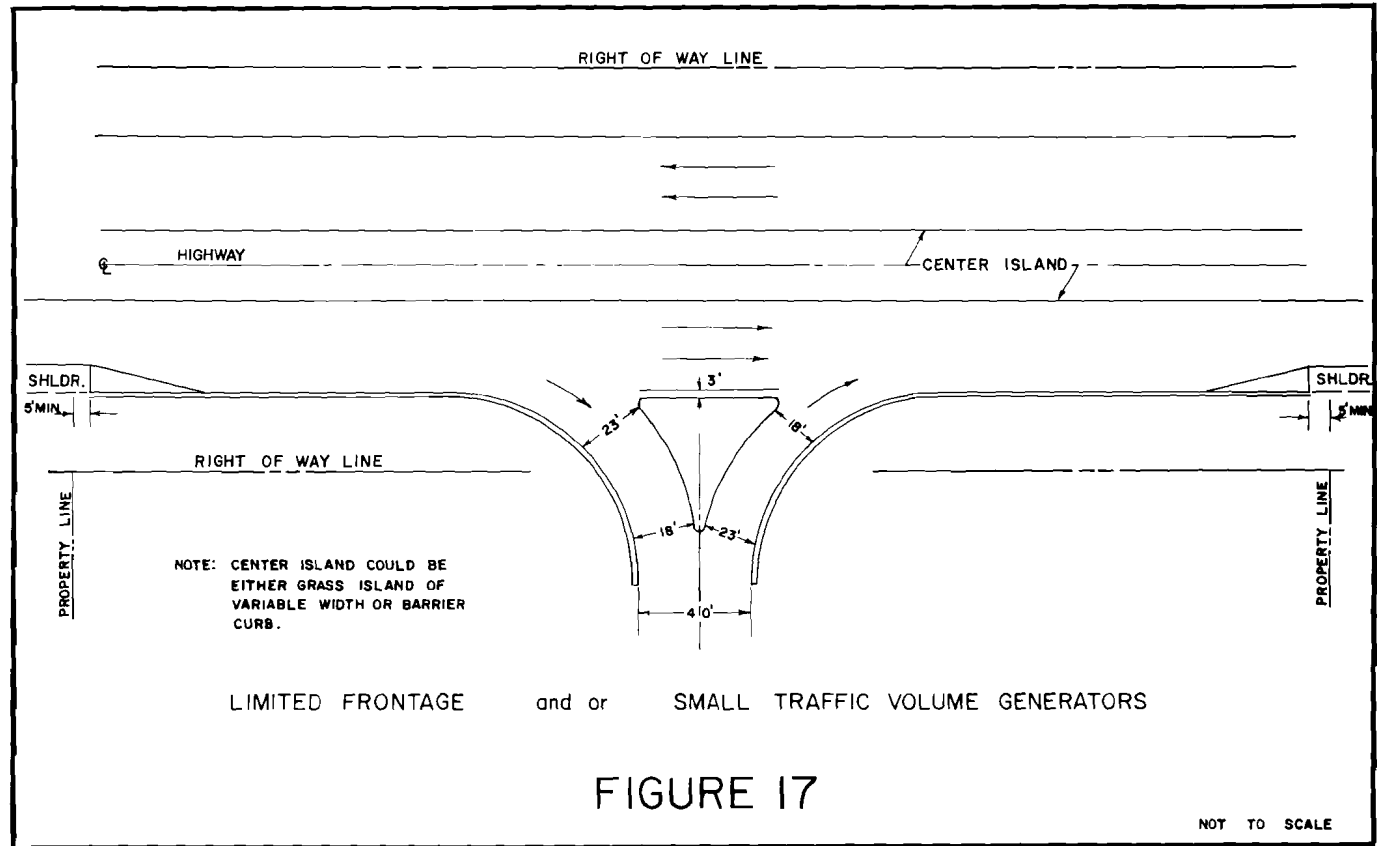
Please note curb construction indicated on the following sketches. On such designs, the Department requires the construction of 9" x 20" white concrete vertical curb. There will be no following through with curb depressions as previously mentioned when constructing curbing for standard driveways.

All islands (except as shown in Fig. 18) must be paved with either Concrete or Bituminous Concrete, in accordance with New Jersey Department of Transportation Specifications. The surface then shall be painted or covered with a Greencote material. The product used must be approved by the Department.

46

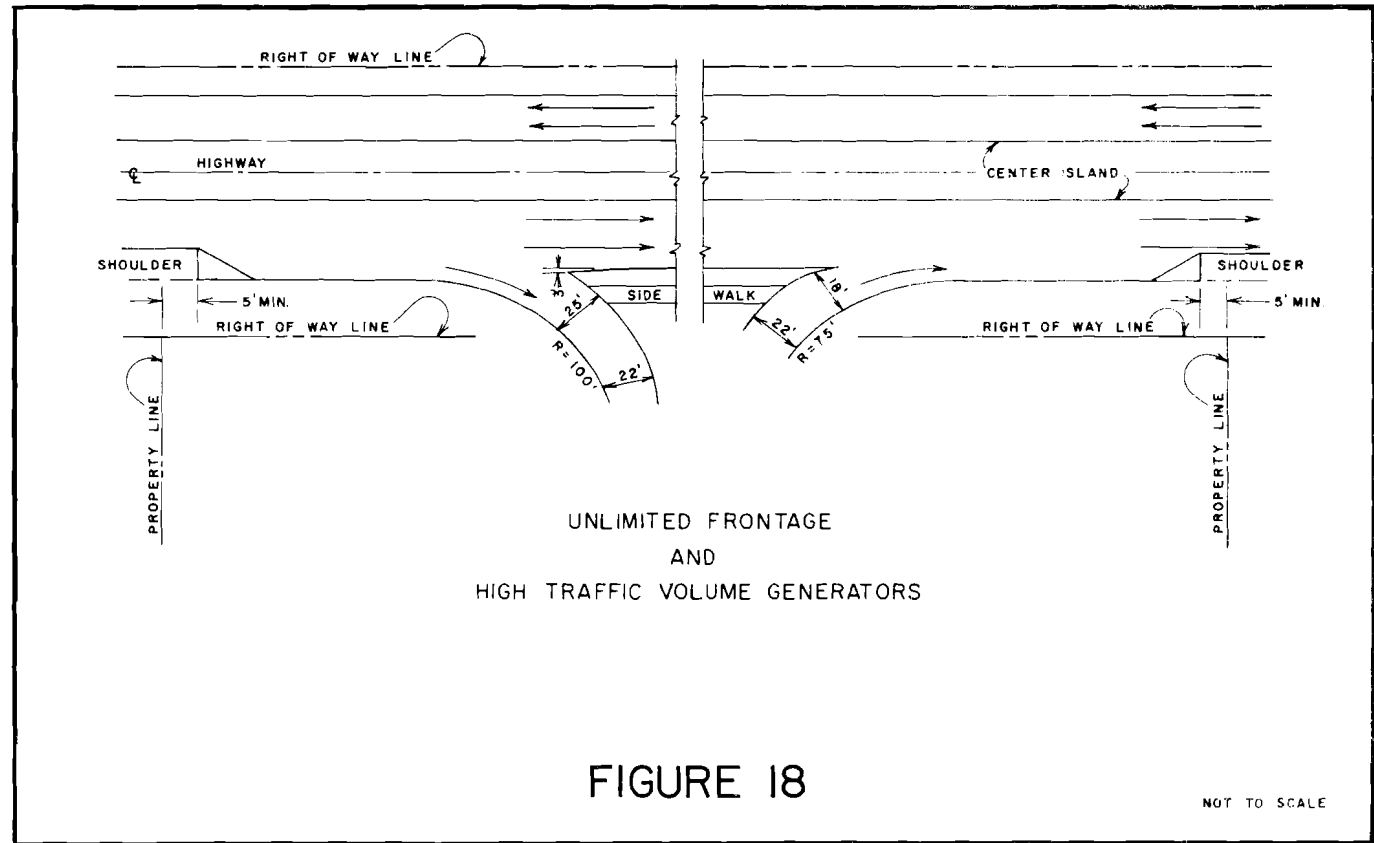


**FIGURE 16: DUAL DRIVEWAY:** Figure 16 shows a suitable driveway connection to apartment dwellings adjacent to a four-lane undivided highway. The preferred angle of the drive is 90 degrees. Frontage of the property and the volume of traffic will be the determining factors in governing the size radii to be used. Notice that the starting points of the radii must have the minimum edge clearance of five (5) feet from the extended property lines and the island separation must be on an offset, three (3) feet from the curbline.



**FIGURE 17: SMALL TRAFFIC VOLUME GENERATORS:** This type entrance is located along a highway that is physically divided, either by a barrier curb or a median strip. It is designed with the use of acceleration and deceleration lanes. The length of these lanes and also radii construction is subject to frontage limitations. They would parallel the edge of the main-traveled way to a width, including the shoulder area plus part of the sidewalk area if necessary, to meet requirements set by the Department in each particular case. If the design includes part of the sidewalk area, the Department will require the property owner dedicate to the State Department of Transportation an equal amount in depth to compensate for that necessary to accommodate the widening, thus maintaining the existing sidewalk width. Notice that the starting points of the radii must have the minimum edge clearance of five (5) feet from the extended property lines and the island separation is on a three (3) foot offset from the curbline.

50



**FIGURE 18. HIGH TRAFFIC VOLUME GENERATORS:** Sketch shows a physically divided highway. There are two separate drives, one used as an entrance and the other as an exit. A deceleration lane is indicated within the shoulder or sidewalk area in advance of the entrance. Then there would be a separating island, the size of which depends upon the location of the exit, followed by construction of an acceleration lane. It should be understood that the construction of driveways including deceleration and acceleration lanes must fall within the frontage of the property.

It would be unpractical to pave the island entirely, due to its size. Therefore, the island shall be topsoiled and seeded, sodded, or ornamentally planted with low growing ground cover. The only part to be paved is a sidewalk strip that must be provided. Location, measurements and specifications would be indicated on the approved plan and as a condition of the permit issued.

**SECTION XXI**  
**VIOLATIONS**

**Regulation Driveway**

- 21.1 **VIOLATION:** Any person, persons, or corporations who violate any of these regulations or their intent, will be subject to Reg. D 21.2.
- 21.2 **PENALTY:** Any person guilty of any violation shall be liable to a fine not exceeding one hundred dollars (\$100) for each such day's violation and the costs of prosecution to be recovered by a civil action in the name of the State before any court of competent jurisdiction, by the Commissioner. See page 2 under Section II.

**SECTION XXII**  
**CONCLUSION**

These regulations will be applied uniformly throughout the state. In cases where the applicant and Regional Engineer disagree on application of these regulations, an appeal may be submitted to the Bureau of Maintenance, Permits Section, for interpretation by the Chief, Bureau of Maintenance. The Chief, Bureau of Maintenance shall arbitrate those disagreements as an Administrative Assistant to the Chief Engineer, Construction and Maintenance.

Should any part of these regulations be in violation of the laws made and provided, only that part which is invalid will be removed and the remaining regulations will continue in full force and effect.

## INDEX

- Abbreviations, 7, 8, 12, 27
- Acceleration Lanes, 4, 8, 25, 44, 49, 51
- Access
  - application, 3
  - control of, 7
- Advertising
  - planning roadside enterprises, 1
  - signs or devices, 17
- Aggregates
  - class B concrete, 12
  - class C concrete, 16
  - driveway surfacing, 19
  - joints, 16
  - white concrete, 12
- Alinement
  - curb, 12
  - driveway, 21
  - sidewalk, 16
- Alteration to driveway, 18
- Angle of driveway, 20
- Application of permits, 2, 3, 4
- Areas
  - unimproved, 13
  - improved, 13
  - sidewalk, 13, 16
- Berm
  - definition, 7
  - unimproved area, 13
- Bituminous Concrete, 20
- Blue Stone Curb, 13
- Bond, guarantee, 26
- Cables, Under Drives, 22
- Catch Basin, Existing, 18
- Center line, abbreviation, 27
- Central Office, 5
- Certified Clerk, guarantee, 26
- Clearance
  - corner, 7, 21
  - edge, 8
- Commercial Major, definition, 7
- Commercial Minor, definition, 7
- Common Drives, 25
- Complex, driveway designs, 45-51
- Conclusion, 52
- Concrete
  - class B, 12
  - class C, 16
- Conditions
  - guarantee, 26
  - high traffic volume generators, 44
  - issuing permits, 26
- Construction, within R.O.W., 18
- Control
  - access, 7
  - dimensions
    - alinement and profile, 21
    - corner clearance, 21
    - distance between drives, 21
    - driveway angle, 20
    - driveway width, 20
    - edge clearance, 20
    - radii, 20
    - setback, 21
- Corner
  - clearance
    - definition, 7
    - dimensions, 21
    - property, 19
    - where traffic signals exist, 21
- Curb
  - alinement and grade, 12
  - construction for complex designs, 45
  - depressions
    - existing curb, 13, 25
    - granite or blue stone, 13
    - height, 14
    - integral with ramp, 13
    - monolithic, 8, 13
    - new construction, 13, 25
  - description, 12
  - expansion joints, 12
  - requirements, 12
  - removal of, 22
  - specifications, class B concrete, 12
  - 9" x 20" W.C.V.C., 12
  - type of finish, 12
- Curbline
  - abbreviation, 27
  - definition, 7
  - opening, 7, 20
- Deceleration Lane, 4, 25, 44, 49, 51
  - berm, 7
  - control of access, 7
  - corner clearance, 3, 7
  - curbline, 7
  - curbline opening, 3, 7
  - distance between drives, 21
  - driveway width
    - complex, 8
    - standard, 3, 8
  - edge clearance, 8
  - extended property line, 8
  - frontage, 8
  - inside radius, 8
  - median, 8
  - monolithic curb, 8
  - outside radius, 8
  - right-of-way, 8
  - right-of-way line, 8
  - setback, 8
  - shoulder, 12
  - sidewalk area, 8
- Depression (see Curb:)
- Dimensions
  - corner clearance, 21
  - distance between drives, 21
  - driveway
    - angle, 20
    - width, 20
  - edge clearance, 20
  - radii, 20
  - setback, 21

INDEX -- Continued

- Distance between Drives
  - control dimensions, 20
  - definitions, 7
- District Offices
  - location, 5
  - boundaries, 6
- Ditches, 16
- Drainage
  - protection of, 18
  - relocation, 22
  - rights, 18
- Driveways
  - alignment and profile, 21
  - alteration, 18
  - angle, 7, 20
  - arrangement
    - frontage less than 100', 19
    - frontage of 100' or more, 19
    - two or more, 19
  - complex designs, 45, 50
  - corner property, 19
  - joint or common, 19
  - radii, 20
  - surfacing, 19
  - width
    - complex, 8
    - standard, 8
- Duration, permits, 4
- Easement, 16
- Edge
  - clearance
    - control dimension, 20
    - definition, 26
- Encroachment
  - penalty, 2
  - restrictions, 17
  - within R.O.W., 2
- Expansion joints, 16
- Expenditures
  - pipes, headwalls, and manholes, 16, 17
  - to obtain access, 23
- Extended property line
  - abbreviation, 27
  - definition, 8
- Extension, Permits, 4
- Fees
  - application fees
    - private driveway, 4
    - combined residence and business, 4
    - automobile service station, 4
    - commercial minor, 4, 7
    - commercial major, 4, 7
  - Extension fees
    - private driveways, 4
    - all others, 4
    - refund, 4
- Fill
  - sidewalk area, 16
  - property, 18
- Filler, for joints, 16
- Fire Hydrants, relocation, 23
- Freeways, 23
- Frontage
  - definition, 8
  - less than 100', 19
  - 100' or more, 19
- Generators traffic
  - condition, 44
  - typical designs, 46, 48, 50
- Grade
  - curb, 12
  - paving at curbline, 19
  - sidewalk, 16
- Driveway, 28, 29
- Granite Stone, curb, 13
- Gravel, surfacing, 19
- Grooves, surface, 16
- Guarantee, bond, 26
- Guard Rail, removal, 22
- Gutterline
  - abbreviation, 27
  - definition, 7
- Headwalls, 15
- Height
  - berm, 7
  - curb
    - depression, 14
    - monolithic, 14
- Highways
  - existing, 25
  - freeways, parkways, and interstate, 23
  - under construction, 25
- Illustrations
  - conduit installation, 24
  - curb, 14
  - definition, 9-11, 27
  - depressed curb, 15
  - driveway
    - complex, 46, 48, 50
    - profile controls, 28
    - standard, 30, 32, 34, 36, 38, 40, 42
    - district boundaries, 6
- Inlets, 22
- Intersection, signalized, 26
- Interstate Routes, 23
- Joint, driveway, 19
- Joints
  - expansion, 12
  - longitudinal, 16
- Jurisdiction
  - district offices, 5
  - pipes, 16
  - structures, 21
- Landscaping
  - ground cover, 25
  - planning roadside enterprises, 1
  - removal or relocation, 25
  - trees, 25
- Lanes, acceleration and deceleration, 25
- Lateral, property lines, 8

**INDEX – Continued**

- Laws
  - affecting highway, 2
  - encroachments, 2
  - ordinances and regulations, 26
- Lighting equipment, 18
- Line
  - curb, 7
  - gutter, 7
  - extended property, 8
  - right-of-way, 8
- Longitudinal joints, 16
- Macadam, driveway base, 20
- Manholes, 17
- Map, district boundaries, 6
- Materials
  - cost, 23
  - inspection, 23
  - requirements, 23
- Maximum
  - angle, 20
  - driveway widths, 20
  - radii, 20
- Median definition, 8
- Minimum
  - angle, 20
  - corner clearance, 21
  - distance between drives, 21
  - edge clearance, 20
  - radii, 20
  - setbacks, 21
  - where traffic signals exist, 21
- Monolithic, Curb, 8, 13
- Offices
  - boundaries, 6
  - central, 5
  - district, 5
- Opening, curbline, 7, 20
- Ordinances
  - driveway width, 26
  - setbacks, 26
- Parking
  - internal, 26
  - planning roadside enterprise, 1
  - sidewalk area, 17
- Parkways, 23
- Pavement
  - new restriction, 18
  - thickness
    - concrete, 20
    - blacktop, 20
- Paving at curbline, 19
- Penalties
  - construction, 2, 52
  - encroachment, 2, 52
- Permits
  - application, 2
  - conditions, 26
  - duration, 4
  - extension, 4
  - fees, 4
  - guarantee, 26
  - penalty, 52
  - renewal, 4
  - plans, 3
  - types, 3
  - violations, 52
  - when required, 2
- Pipes
  - along frontage, 16
  - cost, 17
  - jurisdiction, 16
  - under drives, 16
- Plans
  - supporting application, 3
  - supporting complex design, 44
- Poles
  - relocation of
    - utility, 22
    - highways, 22
- Policy
  - construction of drives
    - existing highways, 25
    - highway under construction, 25
- Profile, driveway, 21, 28, 29
- Property
  - line
    - abbreviation, 27
    - extended, 8
    - lateral, 8
- Protection
  - from suits, 18
  - of structures and drainage, 18
  - of traveling public, 17
- Provisions, permits (see permits)
- Radius
  - abbreviation, 27
  - control dimensions, 20, 21
  - types, 8
- Relocation
  - drainage structures, 22
  - electrical
    - cables under drives, 22
    - facilities, 22
  - signs, 22
  - fire hydrants, 23
  - highway lighting poles, 22
  - landscaping, 25
  - official signs, 22
  - utility poles, 22
- Removal
  - curb, 22
  - guard rail, 22
  - landscaping, 25
- Requirements
  - curb (see curb)
  - high traffic volume generators, 44
  - permits (see permits)
- Residential, driveway surfacing, 19
- Restoration, 26
- Restrictions
  - advertising signs and devices, 17
  - alteration to driveway, 18

**INDEX — Continued**

- construction within R.O.W., 18
- drainage rights, 18
- encroachments, 17
- existing catch basin, 18
- lighting, 18
- new pavement, 18
- parking, 17
- protection
  - from suits, 18
  - of structures and drainage, 18
  - of the traveling public, 17
  - trees and shrubbery, 17
- Right-of-Way
  - abbreviation, 27
  - definition, 8
  - surplus, 25
- Right-of-Way line, definition, 8
- Setback
  - control dimensions, 21
  - definition, 8
  - in planning roadside enterprises, 1
- Shoulder, definition, 12
- Shrubbery
  - jurisdiction, 17
  - shrubs (see landscaping)
  - trimming or removal, 17
- Sidewalk
  - abbreviation, 27
  - alignment and grade, 16
  - concrete
    - finish, 16
    - longitudinal joints, 16
    - surface grooves, 16
    - transverse joints, 16
    - specifications, 16
  - description, 16
  - slope, 16
- Sidewalk Area
  - definition, 8
  - improved, 13
  - requirements, 13
  - sidewalk (see sidewalk)
  - unimproved, 13
- Signalized intersection, 26
- Signs
  - advertising, 1
  - advisory, direction and regulatory, 4
  - relocation of, 17
- Sketches
  - complex driveway designs, 46, 48, 50
  - conduit installation, 22
  - curb construction, 14
  - district boundaries, 6
  - driveway profile controls, 28
  - illustrating definitions, 9-11
  - method of depressing curb, 15
  - typical driveway layouts, 30, 32, 34, 36, 38, 40, 42
- Slope, sidewalk, 16
- Specifications
  - concrete
    - class B, 12
    - class C, 16
  - sidewalks, 13
  - traffic volume generators, 44
- Strip, median, 8
- Structures
  - county or municipal, 22
  - jurisdiction, 21
- Surface, grooves, 16
- Surface, driveways, 19
- Surplus, right-of-way, 25
- Survey, traffic, 26
- Swale, drainage, 28, 29
- Terms, 27
- Theater, drive-in, 25
- Traffic, survey, 26
- Transverse
  - expansion joints, 16
  - surface grooves, 16
- Trees
  - jurisdiction, 17
  - trimming or removal, 17, 25
- Variable Width, abbreviation, 27
- Violations (see permits)
- Volume, traffic generators, 44
- Width
  - control dimensions, 20
  - driveway
    - complex, 8
    - standard, 8
- Workmanship
  - inspection, 23
  - requirements, 23